

Short Instructions..... 3



Kurzübersicht..... 15



QuickStart 27



Быстрый старт..... 39



Inicio rápido 51



Início rápido 63



Pikakäynnistys 75



Snabbstart..... 87



快速启动 99



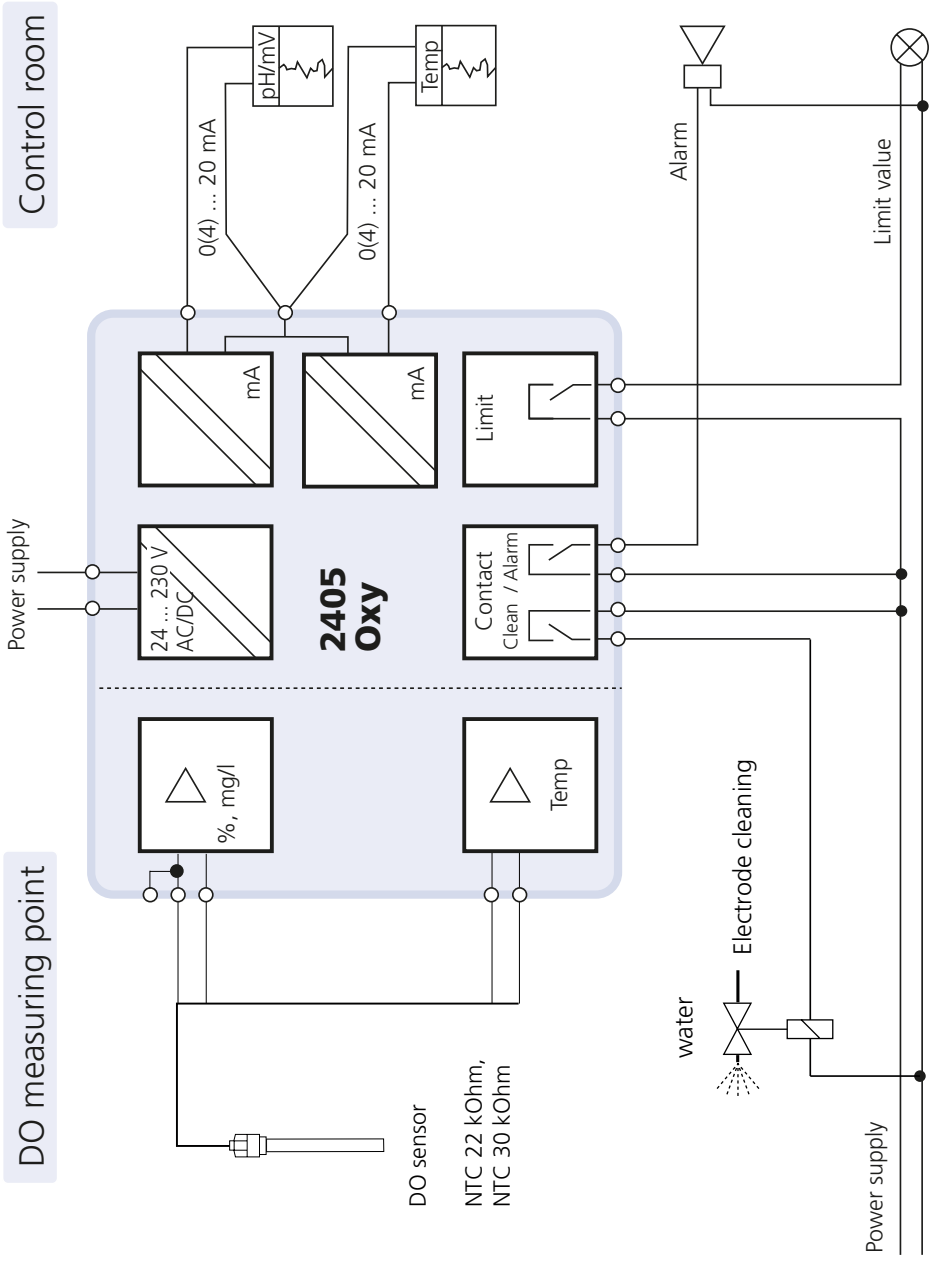



WARNING!

These short instructions are intended for commissioning the Stratos Eco 2405 Oxy transmitters. They are intended for experienced users and do not replace the instruction manual (on included CD-ROM or at www.knick.de).

The shipment includes a special document with safety information.

Stratos Eco 2405 Oxy is used for dissolved oxygen and temperature measurement in biotechnology, pharmaceutical industry, as well as in the field of environment, food processing, and sewage treatment. The sturdy molded enclosure can be fixed into a control panel or mounted on a wall or at a post.

The protective hood provides additional protection against direct weather exposure and mechanical damage.

The device has been designed for application with amperometric sensors, e.g. Knick SE 703 / SE 706. It provides two current outputs (for transmission of measured value and temperature, for example), two contacts, and a universal power supply 24 ... 230 V AC/DC, AC: 45 ... 65 Hz.

Terminals:

Screw terminal, suitable for single wires / flexible leads up to 2.5 mm² (AWG 14).

Recommended torque for the terminal screws: 0.5...0.6 Nm.

Sensor Connection

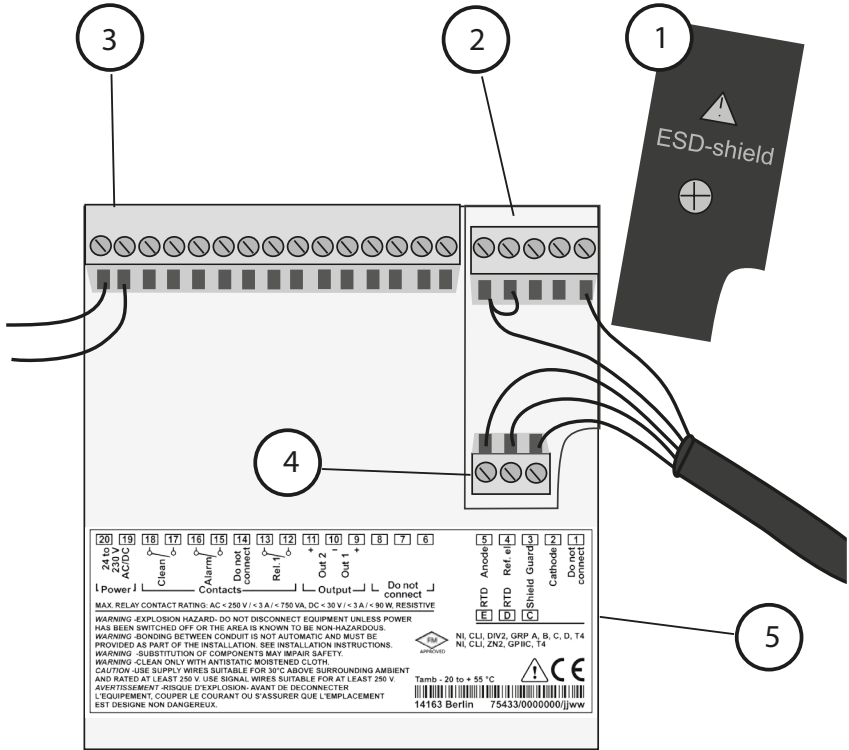

- 1 ESD shield covering the signal inputs (Screw off for assembly)
Note: The cable shield must end under the ESD shield. (Cut lines if required.)
- 2 Terminals for sensor
- 3 Power supply connection
- 4 Terminals for temperature probe and outer shield
- 5 Specifications for terminal assignment

Division 2 Wiring



The connections to the device must be installed in accordance with the National Electric Code (ANSI NFPA 70) Division 2 hazardous (classified) location non-incendive wiring techniques.

Sensors with Connection via VP Cable

Stratos Eco 2405 Oxy

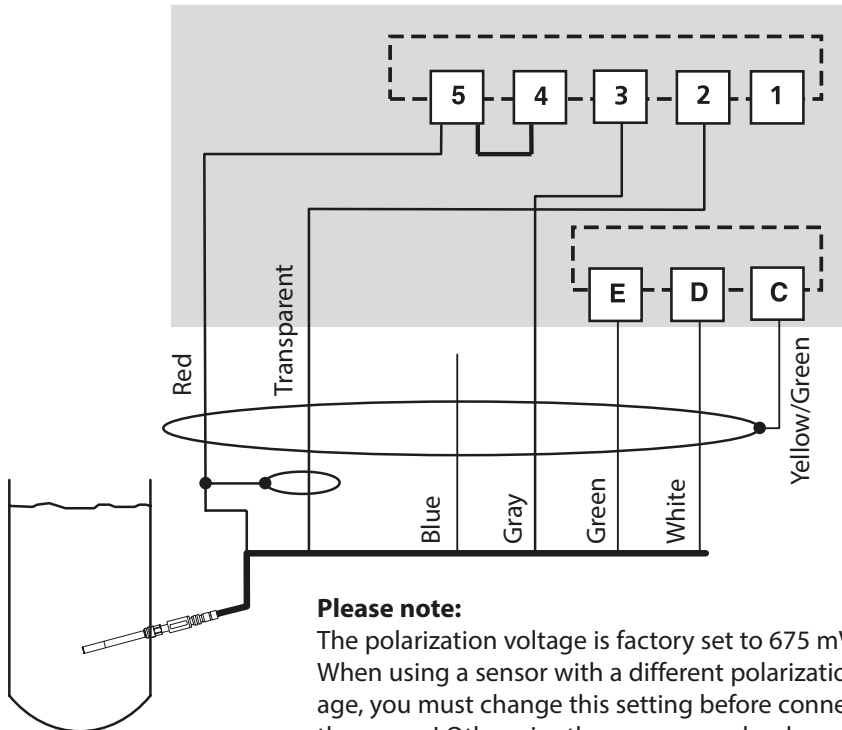

Please note:

The polarization voltage is factory set to 675 mV. When using a sensor with a different polarization voltage, you must change this setting before connecting the sensor! Otherwise the sensor may be damaged!

Connection	Terminal	SE 703/SE 706 sensor VP cable (e.g. ZU 0313)
	1	Do not connect!
cathode	2	Transparent (coax core)
guard	3	Gray
ref. el.	4	(Jumper 4-5)
anode	5	Red (coax shield)
RTD	E	Green
RTD	D	White
shield	C	Yellow/Green

Quickstart

Measuring Mode

After the operating voltage has been connected, the analyzer goes to "Measuring" mode. From the "Calibration" mode, you can switch the analyzer to "Measuring" mode by pressing the **cal** key, from the "Configuration" mode by pressing **conf** (waiting time for measured-value stabilization approx. 20 sec).

Sensoface indicator
(sensor status)

Process
variable

Temperature

Mode indicator
(measuring)

Keypad

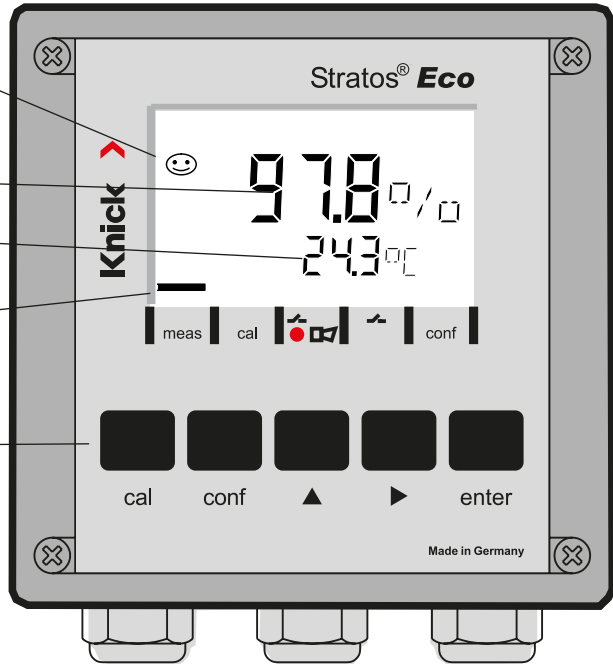

Sensocheck, Sensoface Sensor Monitoring

Sensocheck continuously monitors the sensor and its wiring. Sensocheck can be switched on/off (default: off).



Sensoface provides information on the sensor condition. The slope and response time during calibration are evaluated. The three Sensoface indicators provide the user with information on wear and required maintenance of the sensor.

Keypad

cal	Start, end calibration
conf	Start, end configuration
▶	<ul style="list-style-type: none"> Select digit position (selected position blinks) Menu navigation
▲	<ul style="list-style-type: none"> Edit digit Menu navigation
enter	<ul style="list-style-type: none"> Calibration: Continue in program sequence Configuration: Confirm entries, next configuration step Measuring mode: Display output current
cal → enter	Cal Info: Display of zero and slope
conf → enter	Error Info: Display of last error message
▶ + ▲	Start GainCheck device self-test

Passcodes

Key + passcode	Menu item
cal + 0000	CAL info (display of zero,slope)
cal + 1001	Zero calibration
cal + 1100	Calibration (water / air)
cal + 1105	Product calibration (zero)
cal + 1015	Temp probe adjustment

Configuration

Key + passcode	Menu item
conf + 0000	Error info (display of last error, erase)
conf + 1200	Configuration
conf + 2222	Sensor monitor (sensor current)
conf + 5555	Current source 1 (specify output current)
conf + 5556	Current source 2 (specify output current)
conf + ▶ + 4321	Factory setting

Changing the Mode / Entering Values

Make sure that the device is in “Measuring” mode:

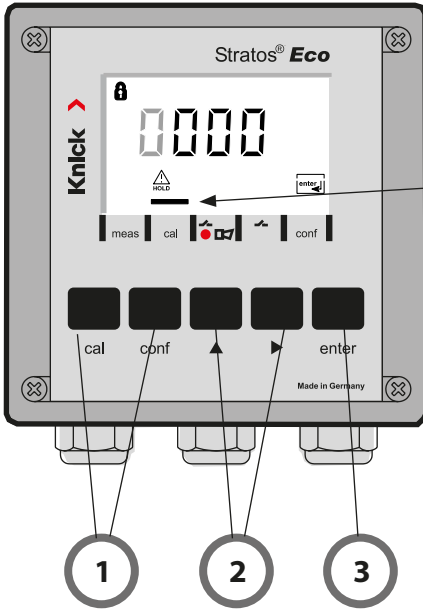

Indication of selected mode
(here calibration)

- 1) Press the corresponding key for calibration – **cal**
for configuration – **conf**







Passcode Entry

- 2) Select numeral using **▶**,
edit number using **▲**
- 3) Confirm entry with **enter**

Overview of Configuration





The configuration steps are assigned to different menu groups. With the arrow keys you can jump between the individual menu groups.



Each menu group contains menu items for setting the parameters. Pressing **enter** opens a menu item. The values are edited using the arrow keys. Pressing **enter** confirms/stores the settings. Return to measurement: Press **conf**.

Select menu group	Menu group	Code	Display	Select menu item
▶	Output 1	o1.		enter
		Menu item 1		enter
		Menu item 2		enter
		:		enter
		Menu item ...		enter
▶	Output 2	o2.		
▶	Temperature compensation	tc.		
▶	Calibration mode	CA.		Previous menu group:
▶	Alarm settings	AL.		
▶	Relay	rL.		

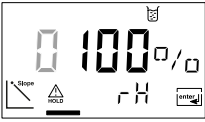
Calibration

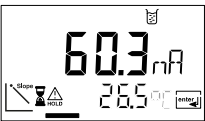
Calibration to Percent Saturation (SAT), in Water

Display	Action	Remark
	<p>Press cal key, enter code 1100. Select with ▶ key, edit number with ▲ key, proceed with enter.</p>	<p>SAT or Conc calibration is selected during configuration.</p> <p>If an invalid code is entered, the device returns to measuring mode.</p>
	<p>Immerse sensor in cal medium</p> <p>Start with enter.</p>	<p>Device is in the Hold mode.</p>
	<p>Enter relative humidity Select using ▶ , enter number using ▲ . Confirm entry with enter.</p>	<p>Default for relative humidity in aqueous media: rH = 100 % (in air approx. 50 %)</p>
	<p>Enter calibration pressure Select using ▶ , enter number using ▲ . Confirm entry with enter.</p>	<p>Default for calibration pressure is the process pressure configured</p>
	<p>Automatic drift check Display of sensor current (related to 25 °C and 1013 mbars normal pressure) and measuring temperature.</p> <p>The drift check might take some time.</p>	<p>Drift check can be stopped after > 10 sec by pressing cal (accuracy reduced).</p>















Display	Action	Remark
	Enter setpoint value for saturation Select with ▶ key, edit number with ▲ key, proceed with enter .	Default: last value entered
	Display of new slope and zero point (related to 25°C at 1013 mbars). End calibration with enter .	New calibration: Press cal key.
	Place sensor in process. The percent saturation is shown in the main display alternately with "Hold"; "enter" blinks. End with enter .	After end of calibration, the outputs remain in Hold mode for approx. 20 sec.

Information on Saturation Calibration (SAT) in Water

- The calibration medium should be water which is in equilibrium with the ambient air (percent saturation 100%). Oxygen exchange between water and air is very slow, however.
- If the calibration medium is not in equilibrium with air and the percent saturation is known from a simultaneous measurement, it can be entered manually.
- For 2-point calibration, perform zero calibration first!

Error Messages

Error	Display	Problem Possible causes	Alarm contact	Red LED	out 1 (22 mA)*	out 2 (22 mA)*
ERR 01	Measured value blinks	SAT range <ul style="list-style-type: none"> • Sensor defective • Wrong sensor connected • Measurement range exceeded 	x	x	x	
ERR 02	Measured value blinks	Conc range <ul style="list-style-type: none"> • Sensor defective • Wrong sensor connected • Measurement range exceeded 	x	x	x	
ERR 98	"Conf" blinks	System error Configuration or calibration data defective; completely reconfigure the device using the factory settings. Then calibrate. Memory error in device program	x	x	x	x
ERR 99	"FAIL" blinks	Factory settings EEPROM or RAM defective This error message only occurs in the case of a total defect. The device must be repaired and recalibrated at the factory.	x	x	x	x

Error	Icon (blinks)	Problem Possible causes	Alarm contact	Red LED	out 1 (22 mA)*	out 2 (22 mA)*
ERR 03		Temperature probe Open or short circuit Temperature range exceeded	x	x	x	x
ERR 11		Current output 1 Current below 0 (3.8) mA	x	x	x	
ERR 12		Current output 1 Current above 20.5 mA	x	x	x	
ERR 13		Current output 1 Current span too small / too large	x	x	x	
ERR 21		Current output 2 Current below 0 (3.8) mA	x	x		x
ERR 22	 	Current output 2 Current above 20.5 mA	x	x		x
ERR 23	 	Current output 2 Current span too small / too large	x	x		x
ERR 33		Sensocheck Glass electrode	x	x	x	
		• Zero error, Sensoface active				
		• Slope error, Sensoface active				
		• Response time exceeded, Sensoface active				
		• Calibration interval expired, Sensoface active				

* if output has been set to Alarm = 22mA during configuration

Bestimmungsgemäßer Gebrauch



WARNUNG!

Diese Kurzübersicht ist für die Inbetriebnahme der Transmitter Stratos Eco 2405 Oxy vorgesehen. Sie ist für den erfahrenen Anwender gedacht und kein Ersatz für das Lesen und Befolgen der Anweisungen in der Bedienungsanleitung (auf beiliegender CD-ROM bzw. im Internet auf www.knick.de).

Die Sicherheitshinweise sind als gesonderte Dokumentation im Lieferumfang enthalten.

Stratos Eco 2405 Oxy wird zur Messung von gelöstem Sauerstoff und Temperatur in der Biotechnologie, der Pharmaindustrie sowie im Industrie-, Umwelt-, Lebensmittel- und Abwasserbereich eingesetzt. Das robuste Kunststoffgehäuse gestattet den Schaltschrank- oder die Wand- bzw. Mastmontage.

Das Schutzdach bietet zusätzlichen Schutz vor direkten Witterungseinflüssen und mechanischer Beschädigung.

Das Gerät ist einfach austauschbar und ausgelegt für amperometrische Sensoren, z. B. Knick SE 703 / SE 706. Es verfügt über zwei Stromausgänge (zur Übertragung von z. B. Messwert und Temperatur), zwei Kontakte und eine universelle Netzversorgung 24 ... 230 V AC/DC, AC: 45 ... 65 Hz.

Anschlussklemmen:

Schraubklemmen, geeignet für Einzeldrähte / Litzen bis 2,5 mm².

Empfohlenes Anzugsmoment der Klemmschrauben: 0,5...0,6 Nm.

Sensor anschließen

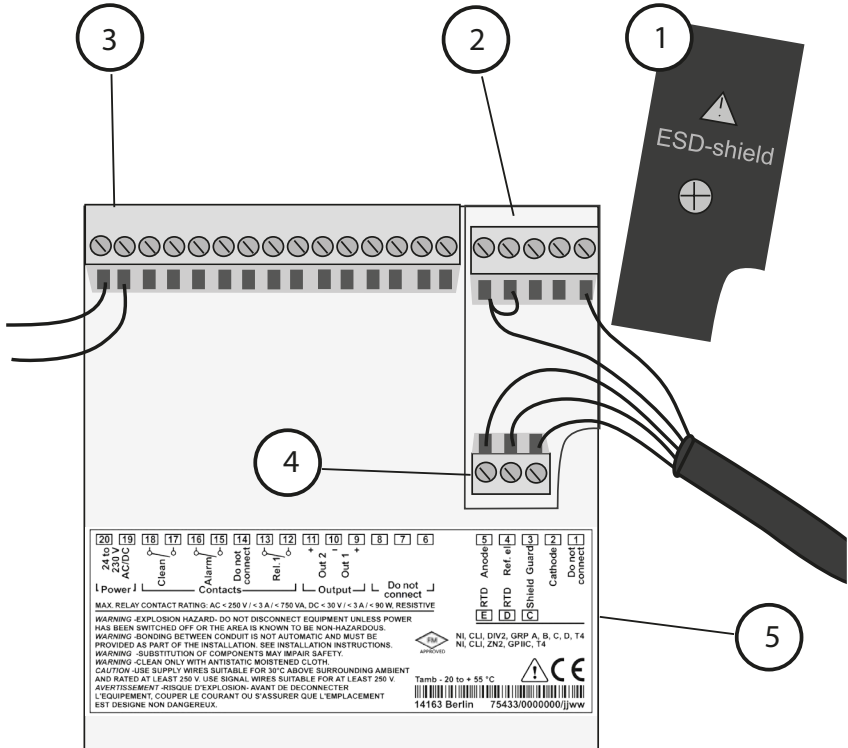

- 1 Schirmkappe über den Signaleingängen (zur Montage abschrauben)
Hinweis: Der Kabelschirm muss unter der Schirmkappe enden (bei Bedarf Leitungen entsprechend kürzen).
- 2 Anschlussklemmen für Sensor
- 3 Anschluss Hilfsenergie
- 4 Anschlussklemmen für Temperaturfühler und Außenschirm
- 5 Angaben zur Klemmenbelegung

Division 2 Wiring



Die Anschlüsse des Gerätes müssen nach den Vorgaben des National Electric Code (ANSI NFPA 70) Division 2 hazardous (classified) location non-incendive wiring techniques errichtet werden.

Sensoren mit Anschluss über VP-Kabel

Stratos Eco 2405 Oxy

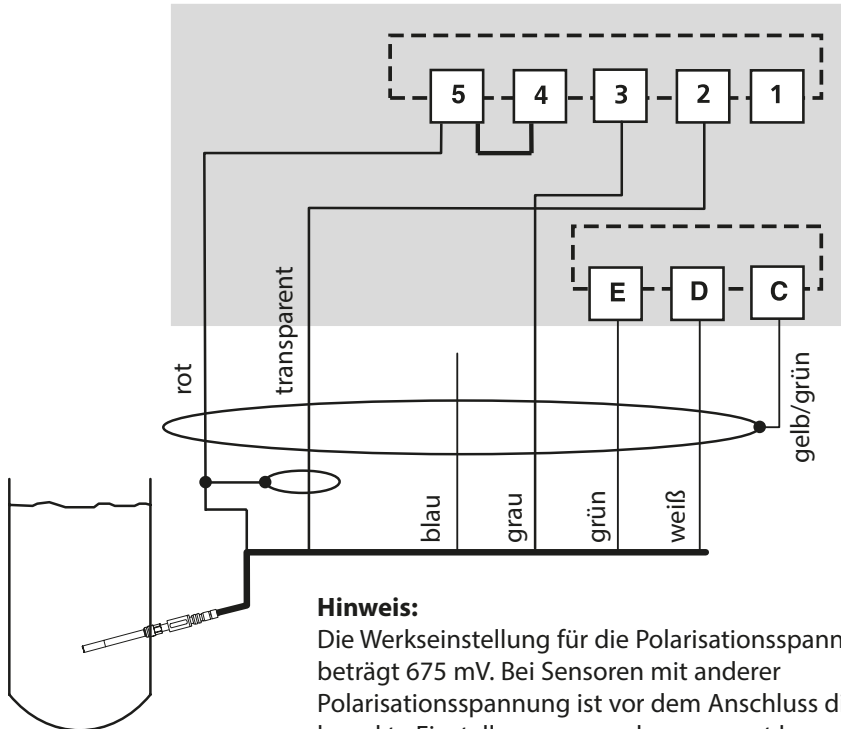

Hinweis:

Die Werkseinstellung für die Polarisierungsspannung beträgt 675 mV. Bei Sensoren mit anderer Polarisierungsspannung ist vor dem Anschluss die korrekte Einstellung vorzunehmen, sonst kann der Sensor Schaden nehmen!

Anschluss	Klemme	Sensor SE 703 / SE 706 VP-Kabel (z. B. ZU 0313)
	1	nicht beschalten!
cathode	2	transparent (Seele Koax)
guard	3	blau
ref. el.	4	Brücke 4-5
anode	5	rot (Schirm Koax)
RTD	E	grün
RTD	D	weiß
shield	C	gelb/grün

Quickstart

Betriebsart Messen

Nach Zuschalten der Betriebsspannung geht das Gerät in die Betriebsart „Messen“. Aus der Betriebsart „Kalibrierung“ wird das Gerät mit **cal**, aus der Betriebsart „Konfigurierung“ mit **conf** in die Betriebsart „Messen“ geschaltet (Wartezeit zur Messwertstabilisierung ca. 20 s).

Sensoface-Anzeige
(Sensorzustand)

Messgröße

Temperatur

Betriebsart-Anzeige
(Messen)

Tastatur

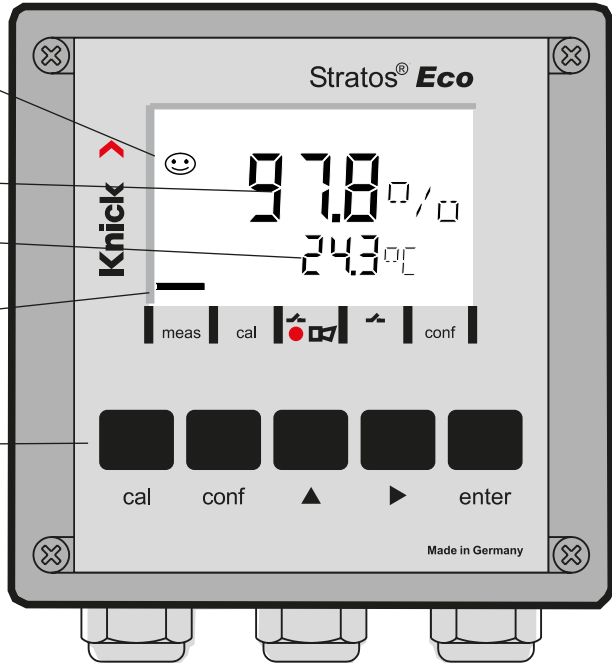

Sensorüberwachung Sensocheck, Sensoface

Sensocheck überwacht kontinuierlich den Sensor und die Zuleitungen. Sensocheck ist parametrierbar (Werkseinstellung: Aus).



Sensoface gibt Hinweise über den Zustand des Sensors.

Es werden Steilheit und Einstellzeit bei der Kalibrierung ausgewertet. Die drei Sensoface-Piktogramme geben Diagnose-Hinweise auf Verschleiß und Wartungsbedarf des Sensors.

Tastatur

cal	Kalibrierung starten, beenden
conf	Konfigurierung starten, beenden
▶	<ul style="list-style-type: none"> Ziffernstelle auswählen (ausgewählte Stelle blinkt) Menünavigation
▲	<ul style="list-style-type: none"> Stelle ändern Menünavigation
enter	<ul style="list-style-type: none"> Kalibrierung: Weiter im Programmablauf Konfigurierung: Eingaben bestätigen, nächster Konfigurierschritt Messmodus: Ausgangsstrom anzeigen
cal → enter	Cal-Info, Anzeige von Nullpunkt und Steilheit
conf → enter	Error-Info, Anzeige der letzten Fehlermeldung
▶ + ▲	Geräteselbsttest GainCheck starten

Passcodes

Taste + Passcode	Menüpunkt
cal + 0000	CAL-Info (Anzeige Nullpunkt, Steilheit)
cal + 1001	Nullpunktkalibrierung
cal + 1100	Kalibrierung (Wasser / Luft)
cal + 1105	Produktkalibrierung (Nullpunkt)
cal + 1015	Abgleich Temperaturfühler

Konfigurierung

Taste + Passcode	Menüpunkt
conf + 0000	Error-Info (Anzeige letzter Fehler, Löschen)
conf + 1200	Konfigurierung
conf + 2222	Sensormonitor (Sensorstrom)
conf + 5555	Stromgeber 1 (Vorgabe Ausgangsstrom)
conf + 5556	Stromgeber 2 (Vorgabe Ausgangsstrom)
conf + ▶ + 4321	Werkseinstellung

Betriebsart wechseln / Werte eingeben

Voraussetzung –

Gerät befindet sich in der Betriebsart „Messen“:

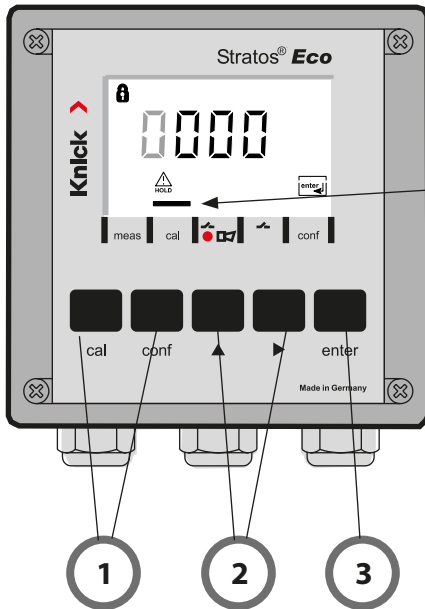

Anzeige der gewählten Betriebsart
(hier Kalibrierung)

- 1) Taste entsprechend der gewünschten Betriebsart drücken
für Kalibrierung - **cal**
für Konfigurierung - **conf**

Eingabe Passcode

- 2) Ziffernposition auswählen mit Taste ▼ ,
Zahlenwert ändern mit Taste ▲
- 3) Eingabe bestätigen mit Taste **enter**

Übersicht Konfigurierung

Die Konfigurierschritte sind in Menügruppen zusammengefasst. Mit Hilfe der Pfeiltasten kann zur jeweils nächsten Menügruppe vor- bzw. zurückgesprungen werden.





Jede Menügruppe besitzt Menüpunkte zur Einstellung der Parameter. Öffnen der Menüpunkte mit **enter**. Das Ändern der Werte erfolgt mit den Pfeiltasten, mit **enter** werden die Einstellungen bestätigt/übernommen.



Zurück zur Messung: **conf** drücken.

Wahl Menügruppe	Menügruppe	Code	Display	Wahl Menüpunkt
	Ausgang 1	o1.		enter
		Menüpunkt 1		enter
		Menüpunkt 2		enter
		Menüpunkt ...		enter
	Ausgang 2	o2.		
	Temperatur- kompensation	tc.		
	Kalibriermodus	CA.		vorige Menügruppe:
	Alarめinstellungen	AL.		
	Relais	rL.		

Kalibrierung

Kalibrierung auf Sättigungsindex (SAT), in Wasser

Display	Aktion	Bemerkung
	Taste cal drücken, Code 1100 eingeben, Auswahl mit Pfeiltaste ▶ , Zahlenwert mit Taste ▲ , weiter mit enter .	Kalibrierung SAT oder Kalibrierung Conc wird in der Konfiguration vorein- gestellt. Bei ungültigem Code geht das Gerät zurück in den Messmodus.
	Sensor in Kalibriermedium bringen Starten mit enter .	Gerät geht in den Hold-Zustand.
	Eingabe relative Feuchte Auswahl mit Pfeiltaste ▶ , Zahlenwert mit Taste ▲ , Mit enter Eingabe bestätigen.	Vorgabewert für rela- tive Feuchte in wässri- gen Medien: rH = 100 % (an Luft ca. 50 %)
	Eingabe Kalibrierdruck Auswahl mit Pfeiltaste ▶ , Zahlenwert mit Taste ▲ , Mit enter Eingabe bestätigen.	Vorgabewert für Kalibrierdruck ist der konfigurierte Prozessdruck
	Automatische Driftkontrolle Anzeige des Sensorstroms (bezogen auf 25 °C und 1013 mbar Normaldruck) und der Messtemperatur. Die Driftkontrolle kann längere Zeit dauern.	Abbruch mit Taste cal nach > 10 s möglich, dann aber einge- schränkte Genauigkeit















Display	Aktion	Bemerkung
	<p>Eingabe Sollwert für den Sättigungsindex Auswahl mit Pfeiltaste ▶ , Zahlenwert mit Taste ▲ , weiter mit enter.</p>	<p>Voreinstellung ist der zuletzt eingegebene Wert</p>
	<p>Anzeige neue Steilheit und Nullpunkt (bezogen auf 25°C und 1013 mbar) Kalibrierung beenden mit enter.</p>	<p>Erneut kalibrieren: Taste cal drücken</p>
	<p>Sensor wieder in den Prozess bringen. Der Sättigungsindex wird wechselnd mit "Hold" in der Hauptanzeige angezeigt, "enter" blinkt. Beenden mit enter.</p>	<p>Ausgänge bleiben nach Beenden der Kalibrierung noch ca. 20 s im Hold-Zustand.</p>

Hinweis zur Kalibrierung Sättigungsindex (SAT) in Wasser

- Als Kalibriermedium sollte Wasser verwendet werden, das sich im Gleichgewichtszustand mit der Umgebungsluft befindet (Sättigungsindex 100%). Der Sauerstoffaustausch zwischen Wasser und Luft läuft aber nur sehr langsam ab.
- Ist das Kalibriermedium nicht im Gleichgewichtszustand mit der Luft und der Sättigungsindex des Kalibriermediums durch eine parallel ablaufende Messung bekannt, kann er manuell eingegeben werden.
- Bei 2-Punktkalibrierung zuerst eine Nullpunktkalibrierung vornehmen!

Fehlermeldungen

Fehler	Display	Problem mögliche Ursache	Alarmkontakt	rote LED	out 1 (22 mA)*	out 2 (22 mA)*
ERR 01	Messwert blinkt	Messbereich SAT <ul style="list-style-type: none"> • Sensor defekt • falscher Sensor angeschlossen • Messbereich überschritten bzw. unterschritten 	x	x	x	
ERR 02	Messwert blinkt	Messbereich Conc <ul style="list-style-type: none"> • Sensor defekt • falscher Sensor angeschlossen • Messbereich überschritten bzw. unterschritten 	x	x	x	
ERR 98	„Conf“ blinkt	Systemfehler Konfigurations- oder Kalibrierdaten defekt, konfigurieren Sie das Gerät komplett neu über Werkseinstellung. Danach Kalibrieren. Speicherfehler im Geräteprogramm	x	x	x	x
ERR 99	„FAIL“ blinkt	Abgleichdaten EEPROM oder RAM defekt Diese Fehlermeldung tritt nur bei komplettem Defekt auf. Das Gerät muss im Werk repariert und neu abgeglichen werden.	x	x	x	x

Fehler	Symbol (blinkt)	Problem mögliche Ursache	Alarmkontakt	rote LED	out 1 (22 mA)*	out 2 (22 mA)*
ERR 03		Temperaturfühler Unterbrechung bzw. Kurzschluss Temperaturmessbereich über- bzw. unterschritten	x	x	x	x
ERR 11		Stromausgang 1 Strom kleiner 0 (3,8) mA	x	x	x	
ERR 12		Stromausgang 1 Strom größer 20,5 mA	x	x	x	
ERR 13		Stromausgang 1 Stromspanne zu klein / zu groß	x	x	x	
ERR 21		Stromausgang 2 Strom kleiner 0 (3,8) mA	x	x		x
ERR 22	 	Stromausgang 2 Strom größer 20,5 mA	x	x		x
ERR 23	 	Stromausgang 2 Stromspanne zu klein / zu groß	x	x		x
ERR 33		Sensocheck Glaselektrode	x	x	x	
		• Nullpunktfehler, Sensoface aktiv				
		• Steilheitsfehler, Sensoface aktiv				
		• Einstellzeit überschritten, Sensoface aktiv				
		• Kalibriertimer abgelaufen, Sensoface aktiv				

* wenn der Ausgang in der Konfiguration auf Alarm = 22mA parametrierung wurde



AVERTISSEMENT !

Cette brève présentation est destinée à la mise en service du transmetteur Stratos Eco 2405 Oxy. Elle est conçue pour les utilisateurs expérimentés et ne dispense pas de lire et de respecter les instructions du mode d'emploi (contenues dans le CD-ROM joint ou consultables sur le site www.knick.de).

Les consignes de sécurité sont fournies sous forme de documentation distincte.

Le Stratos Eco 2405 Oxy est utilisé pour mesurer l'oxygène dissous et la température dans le domaine de la biotechnologie, dans l'industrie pharmaceutique de même que dans l'industrie et le secteur de l'environnement, des produits alimentaires et des eaux usées.

Le robuste boîtier en plastique permet de le monter sur un tableau de commande, un mur ou un mât.

L'auvent offre une protection supplémentaire contre les intempéries et les dommages mécaniques.

L'appareil peut être changé facilement et est conçu pour les capteurs ampérométriques, tels que Knick SE 703 / SE 706. Il dispose de deux sorties de courant (pour la transmission de la valeur mesurée et de la température, par ex.), de deux contacts et d'une alimentation réseau universelle 24 ... 230 V CA/CC, CA : 45 ... 65 Hz.

Bornes :

Bornes à vis pour fils monobrins et multibrins jusqu'à 2,5 mm².

Couple de serrage recommandé pour les vis des bornes : 0,5...0,6 Nm.

Raccordement du capteur

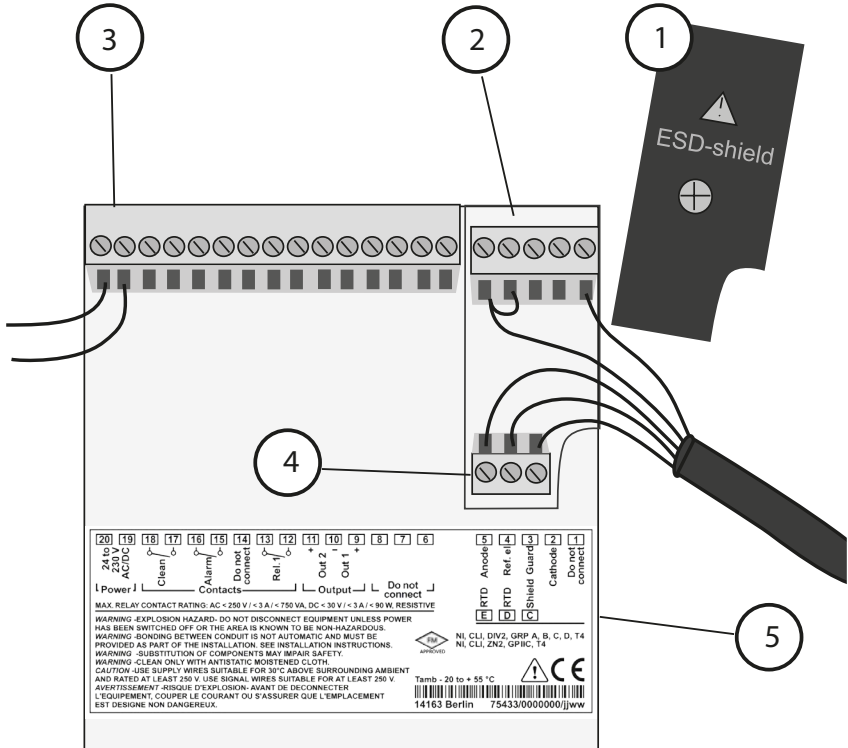

- 1 Blindage des entrées de signaux (à dévisser pour le montage)
Remarque : L'écran du câble doit aboutir sous le blindage (si nécessaire, raccourcir les conducteurs en conséquence).
- 2 Bornes pour capteur
- 3 Raccordement d'alimentation
- 4 Bornes pour sonde de température et écran extérieur
- 5 Correspondance des bornes

Division 2 Wiring



Les raccordements de l'appareil doivent être réalisés conformément aux indications du National Electric Code (ANSI NFPA 70) Division 2 hazardous (classified) location non-incendive wiring techniques.

Capteurs à raccordement par câble VP

Stratos Eco 2405 Oxy

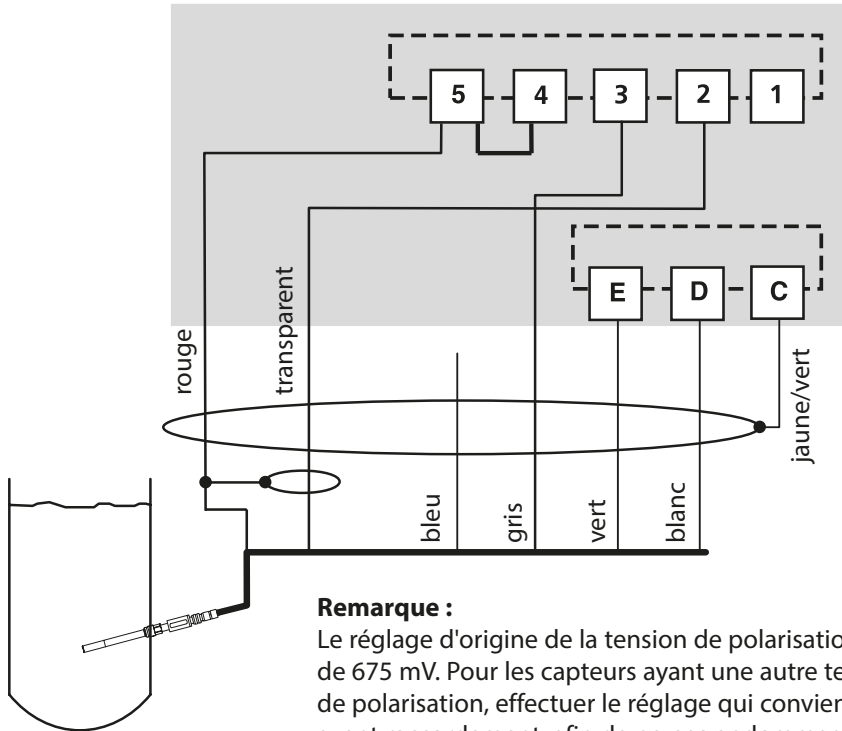

Raccord	Borne	Capteur SE 703/SE 706 Câble VP (par ex. ZU 0313)
	1	Ne pas connecter !
cathode	2	transparent (âme coax)
guard	3	gris
ref. el.	4	shunt 4-5
anode	5	rouge (blindage coax)
RTD	E	vert
RTD	D	blanc
shield	C	jaune/vert

Quickstart

Mode Mesure

Après coupure de la tension de service, l'appareil se met en mode Mesure. Pour passer en mode Mesure, appuyer sur cal (mode Calibrage), sur **conf** (mode Configuration), le temps d'attente jusqu'à stabilisation de la valeur mesurée étant d'env. 20 s.

Symbole Sensoface
(état du capteur)

Paramètre

Température

Affichage du mode
(mesure)

Clavier

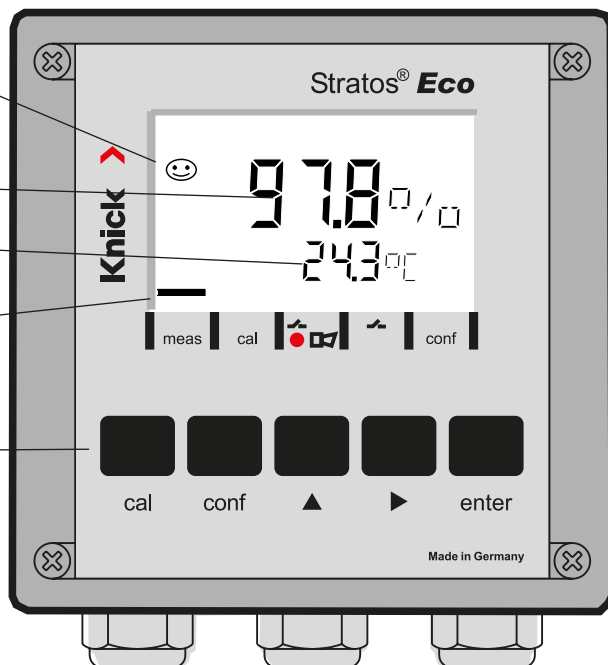

Surveillance du capteur Sensocheck, Sensoface

Sensocheck surveille en permanence le capteur et les câbles. Sensocheck est programmable (réglage d'origine : arrêt).



Sensoface fournit des informations sur l'état du capteur. La pente et le temps de réponse sont analysés au cours du calibrage. Les trois symboles Sensoface fournissent des indications de diagnostic relatifs à l'usure et à la nécessité d'entretien du capteur.

Clavier

cal	Lancer, terminer le calibrage
conf	Lancer, terminer la configuration
▶	<ul style="list-style-type: none"> Sélectionner la position décimale (la position sélectionnée clignote) Navigation entre les menus
▲	<ul style="list-style-type: none"> Modifier la position Navigation entre les menus
enter	<ul style="list-style-type: none"> Calibrage : Suite du déroulement du programme Configuration : Valider les entrées, étape de configuration suivante Mode Mesure : Afficher le courant de sortie
cal → enter	Cal-Info, affichage du zéro et de la pente
conf → enter	Error-Info, affichage du dernier message d'erreur
▶ + ▲	Lancer l'autotest de l'appareil GainCheck

Passcodes

Touche + code d'accès	Point de menu
cal + 0000	CAL-Info (affichage du zéro, pente)
cal + 1001	Calibrage du zéro
cal + 1100	Calibrage (eau / air)
cal + 1105	Calibrage du produit (zéro)
cal + 1015	Compensation de la sonde de température

Configuration

Touche + code d'accès	Point de menu
conf + 0000	Error-Info (affichage de la dernière erreur, suppression)
conf + 1200	Configuration
conf + 2222	Contrôle capteur (courant du capteur)
conf + 5555	Générateur de courant 1 (courant sortie spécifié)
conf + 5556	Générateur de courant 2 (courant sortie spécifié)
conf + ▶ + 4321	Réglage usine

Changement de mode / saisie des valeurs

**Condition préalable –
L'appareil doit être en mode Mesure :**

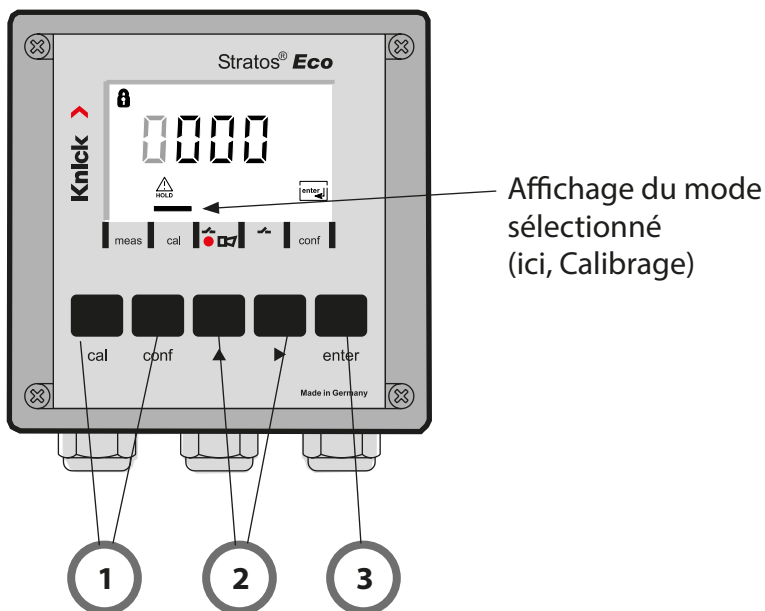

- 1) Appuyer sur la touche correspondant au mode souhaité pour calibrage – **cal**
pour configuration – **conf**

Saisie du code d'accès

- 2) Sélectionner la position du chiffre à l'aide de la touche ▶ ,
Modifier la valeur numérique à l'aide de la touche ▲
- 3) Valider avec **enter**

Vue d'ensemble du menu Configuration

Les étapes de configuration sont réunies en groupes de menus.
Les touches fléchées permettent d'aller au groupe de menus suivant ou de revenir au groupe précédent.

Chaque groupe de menus comprend des points de menu pour le réglage des paramètres.

Presser **enter** pour ouvrir les points de menu.

Utiliser les touches fléchées pour modifier les valeurs et **enter** pour valider/garder les réglages.





Retour à la mesure : presser **conf.**



Sélect. groupe menus	Groupe de menus	Code	Afficheur	Sélect. point menu
▶	Sortie 1	o1.	out.1 MNU △ o1. ▽	enter
		Point de menu 1		enter
		Point de menu 2		enter
		Point de menu ...		enter
▶	Sortie 2	o2.	out2 MNU △ o2. ▽	
▶	Compensation de température	tc.	tc MNU △ tc. ▽	
▶	Mode Calibrage	CA.	CAL MNU △ CA. ▽	
▶	Alarmes	AL.	ALt MNU △ AL. ▽	
▶	Relais	rL.	rLAY MNU △ rL. ▽	

Groupe de menus précédent:

Calibrage

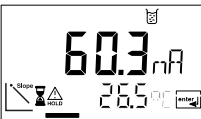
Calibrage en fonction de l'indice de saturation (SAT), dans l'eau

Afficheur	Action	Remarque
	Presser la touche cal , entrer le code 1100, Sélection avec la touche ▶, valeur avec la touche ▲, suite avec enter .	Calibrage SAT ou Calibrage Conc est préréglé dans la Configuration. Si le code est incor- rect, l'appareil repasse en mode Mesure.
	Introduire le capteur dans le milieu de calibrage Démarrer avec la touche enter .	L'appareil se met dans l'état Hold.
	Entrée de l'humidité relative. Sélection avec la touche fléchée ▶, valeur numérique avec la touche ▲. Valider l'entrée avec enter .	Valeur spécifiée pour l'humidité rela- tive dans les milieux aqueux : rH = 100 % (dans l'air env. 50 %)
	Entrée de la pression de calibrage. Sélection avec la touche fléchée ▶, valeur numérique avec la touche ▲, Valider l'entrée avec enter .	La valeur spécifiée pour la pression de calibrage est la pres- sion configurée du processus.
	Contrôle automatique de la dérive Affichage du courant du capteur (rapporté à 25 °C et 1013 mbars de pression normale) Le contrôle de la dérive peut durer un certain temps.	Possibilité de quitter avec la touche cal après > 10 s mais la précision est alors réduite.















Afficheur	Action	Remarque
	Entrée de la valeur de consigne pour l'indice de saturation Sélection avec la touche ▶ , valeur avec la touche ▲ , suite avec enter .	Le réglage par défaut est la dernière valeur entrée.
	Affichage de la nouvelle pente et du zéro (rapportés à 25°C et 1013 mbars) Terminer le calibrage avec enter .	Nouveau calibrage : Presser la touche cal .
	Réinsérer le capteur dans le processus. L'indice de saturation et "Hold" apparaissent en alternance sur l'afficheur principal, "enter" clignote. Terminer avec enter	Une fois le calibrage terminé, les sorties restent encore dans l'état Hold pendant env. 20 s.

Remarque sur le calibrage indice de saturation (SAT) dans l'eau

- Le milieu de calibrage utilisé doit être de l'eau, en équilibre par rapport à l'air ambiant (indice de saturation de 100%). L'échange d'oxygène entre l'eau et l'air ne se fait cependant que très lentement.
- Si le fluide de calibrage n'est pas en équilibre par rapport à l'air et que l'indice de saturation de ce fluide est connu (via une mesure parallèle), il peut être saisi manuellement.
- Dans le cas du calibrage en 2 points, effectuer d'abord un calibrage du zéro.

Messages d'erreur

Erreur	Afficheur	Problème Cause possible	Contact d'alarme	LED rouge	out 1 (22 mA)*	out 2 (22 mA)*
ERR 01	La valeur mesurée clignote	Plage de mesure SAT <ul style="list-style-type: none"> • Capteur défectueux • Mauvais capteur raccordé • Dépassement de la limite supérieure ou inférieure de la plage de mesure 	x	x	x	
ERR 02	La valeur mesurée clignote	Plage de mesure Conc <ul style="list-style-type: none"> • Capteur défectueux • Mauvais capteur raccordé • Dépassement de la limite supérieure ou inférieure de la plage de mesure 	x	x	x	
ERR 98	"Conf" clignote	Erreur système Données de configuration ou de calibrage incorrectes, recommencez entièrement la configuration et le calibrage de l'appareil selon le réglage d'origine. Puis effectuez un calibrage. Erreur de mémoire dans le programme de l'appareil	x	x	x	x
ERR 99	"FAIL" clignote	Données de compensation EEPROM ou RAM défectueuse Ce message d'erreur apparaît uniquement en cas de défaillance totale. L'appareil doit être réparé et recalibré en usine.	x	x	x	x

Erreur	Symbole (clignote)	Problème Cause possible	Contact d'alarme	LED rouge	out 1 (22 mA)*	out 2 (22 mA)*
ERR 03		Sonde de température Interruption ou court-circuit Dépassement de la plage de mesure de la température	x	x	x	x
ERR 11		Sortie courant 1 Courant inférieur à 0 (3,8) mA	x	x	x	
ERR 12		Sortie courant 1 Courant supérieur à 20,5 mA	x	x	x	
ERR 13		Sortie courant 1 Fourchette de courant trop petite / trop grande	x	x	x	
ERR 21		Sortie courant 2 Courant inférieur à 0 (3,8) mA	x	x		x
ERR 22	 	Sortie courant 2 Courant supérieur à 20,5 mA	x	x		x
ERR 23	 	Sortie courant 2 Fourchette de courant trop petite / trop grande	x	x		x
ERR 33		Sensocheck Electrode de verre	x	x	x	
		• Erreur de zéro, Sensoface actif				
		• Erreur de pente, Sensoface actif				
		• Temps de réponse dépassé, Sensoface actif				
		• Minuteur de calibrage écoulé, Sensoface actif				

* si la sortie a été programmée sur Alarme = 22mA dans la configuration

Применение по назначению



Осторожно!

Данный краткий обзор предназначен для ввода в эксплуатацию передатчика Stratos Eco 2405 Oxy. Он предназначен для опытного пользователя и не заменяет чтение и следование указаниям в руководстве по эксплуатации (на прилагающемся CD-ROM или на сайте www.knick.de).

Указания по безопасности входят в комплект поставки как отдельный документ.

Stratos Eco 2405 Oxy применяется для измерения растворенного кислорода и температуры в биотехнологии, фармацевтической отрасли, а также в производстве, экологии, пищевой индустрии и канализационном хозяйстве.

Прочный пластиковый корпус позволяет осуществлять встраивание в распределительный щит, а также монтаж на стене или мачте.

Защитная крышка обеспечивает дополнительную защиту от прямого атмосферного воздействия и механического повреждения.

Прибор отличается простотой монтажа и демонтажа и рассчитан на амперометрические датчики, например, Knick SE 703 / SE 706. Он оснащен двумя токовыми выходами (например, для передачи измеренного значения и температуры), двумя контактами и универсальным сетевым питанием 24 ... 230 В пост./перем. тока, перем. ток: 45 ... 65 Гц.

Соединительные клеммы:

Винтовые клеммы, подходят для отдельных проводов / жил до 2,5 мм².

Рекомендованный момент затяжки для винтов клемм: 0,5...0,6 Нм.

Датчики с подключением по кабелю variopin (VP)

Stratos Eco 2405 Oxy

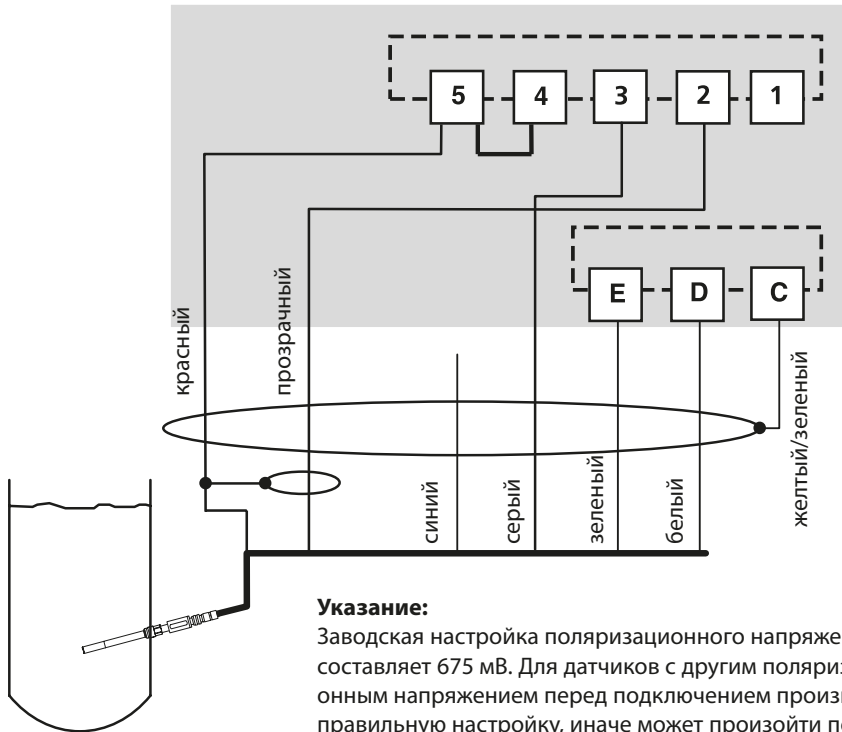

Указание:

Заводская настройка поляризационного напряжения составляет 675 мВ. Для датчиков с другим поляризационным напряжением перед подключением произвести правильную настройку, иначе может произойти повреждение датчика!

Подключение	Клемма	Датчик SE 703 / SE 706 Кабель VP (напр., ZU 0313)
	1	не коммутировать!
cathode	2	прозрачный (жила коакс.)
guard	3	серый
ref. el.	4	перемычка 4-5
anode	5	красный (экран коакс.)
RTD	E	зеленый
RTD	D	белый
shield	C	желтый/зеленый

Быстрый старт

Режим измерения

После включения рабочего напряжения прибор автоматически переходит в режим "Измерение". Прибор переключается в режим "Измерение" из режима "Калибровка" клавишей **cal**, из режима "Конфигурация" клавишей **conf** (время ожидания для стабилизации измеренного значения ок. 20 сек.).

Индикация
Sensoface
(состояние датчика)

Измеряемый
параметр

Температура

Отображение режи-
ма (измерение)

Клавиатура

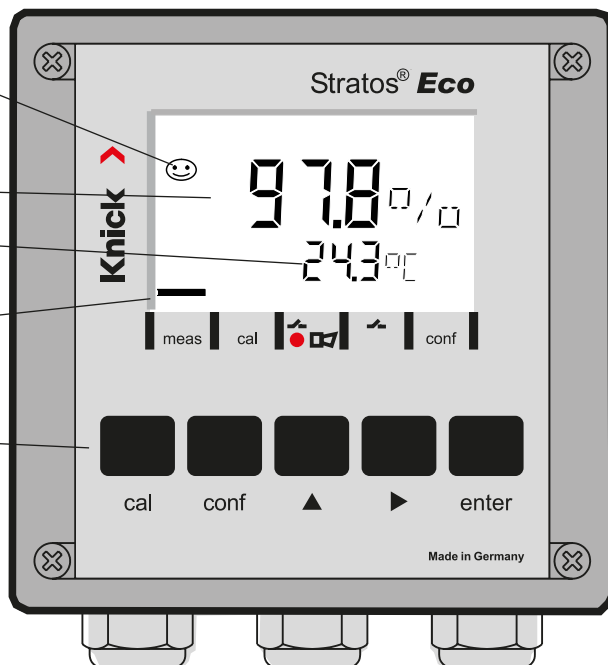

Контроль датчиков Sensoscheck, Sensoface

Sensoscheck непрерывно контролирует датчик и подводящие линии. Sensoscheck можно параметрировать (заводская установка: выкл).



Sensoface дает указания по состоянию датчика.

Крутизна и время настройки анализируются при калибровке.

Три пиктограммы Sensoface дают диагностические указания на износ и необходимое обслуживание датчика.

Клавиатура

cal	Запуск, завершение калибровки
conf	Запуск, завершение конфигурации
▶	<ul style="list-style-type: none"> Выбор разряда числа (выбранный разряд мигает) Навигация по меню
▲	<ul style="list-style-type: none"> Изменение разряда Навигация по меню
enter	<ul style="list-style-type: none"> Калибровка: Дальнейший ход выполнения программы Конфигурация: подтверждение введенного значения, следующий шаг конфигурации Режим измерения: отображение исходного тока
cal → enter	Cal-Info, отображение нулевой отметки и крутизны
conf → enter	Error-Info, отображение последнего сообщения об ошибке
▶ + ▲	Запустить самотестирование прибора GainCheck

Коды-пароли

Клавиша + Коды-пароли	Пункт меню
cal + 0000	CAL-Info (отображение нулевой отметки, крутизны)
cal + 1001	Калибровка нулевой отметки
cal + 1100	Калибровка (вода / воздух)
cal + 1105	Калибровка изделия (нулевая отметка)
cal + 1015	Коррекция температурного зонда

Конфигурация

Клавиша + Коды-пароли	Пункт меню
conf + 0000	Error-Info (отображение последних ошибок, удаление)
conf + 1200	Конфигурация
conf + 2222	Монитор датчика (ток датчика)
conf + 5555	Датчик тока 1 (установка исходного тока)
conf + 5556	Датчик тока 2 (установка исходного тока)
conf + ▶ + 4321	Заводская настройка

Смена режима / ввод значений

Условие -
прибор находится в режиме «Измерение»:

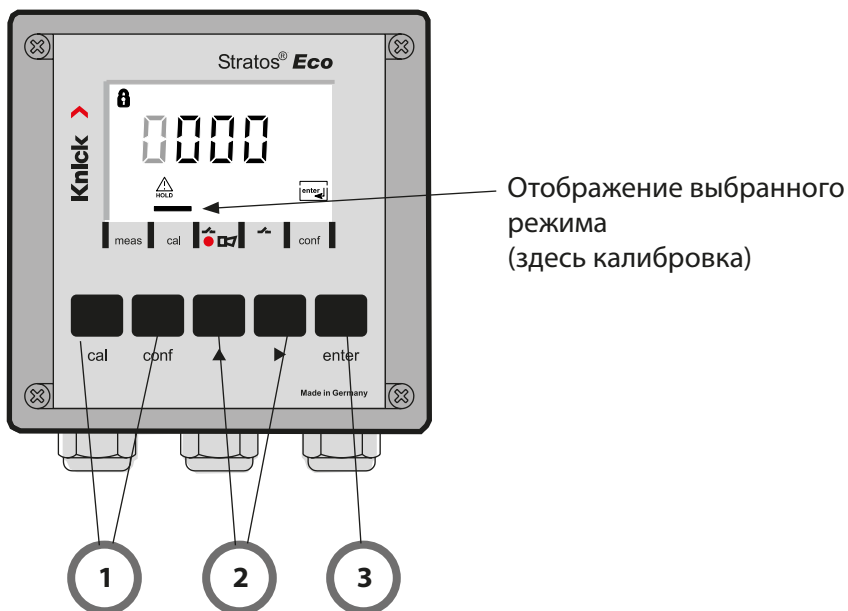

- 1) Нажать клавишу, соответствующую необходимому режиму для калибровки – **cal**
для конфигурации – **conf**

Ввод кода-пароля

- 2) Выбрать разряд числа клавишей **▶** ,
Изменить числовое значение клавишей **▲**
- 3) Подтвердить ввод клавишей **enter**

Обзор конфигурации

Этапы конфигурации обобщены в группах меню.

Клавишами со стрелками можно переходить вперед и назад к следующей группе меню.

Каждая группа меню состоит из пунктов меню для настройки параметров.



Пункты меню открываются клавишей **enter**. Изменение параметров производится клавишами со стрелками, а клавишей **enter** настройки подтверждаются / принимаются.



Назад к измерению: нажать **conf**.

Выбор группы меню	Группа меню	Код	Дисплей	Выбор пункта меню
	Выход 1	o1.		enter
		Пункт меню 1		enter
		Пункт меню 2		enter
		:		enter
		Пункт меню ...		enter
	Выход 2	o2.		
	Компенсация температуры	tc.		
	Режим калибровки	CA.		← Предыдущая группа меню:
	Аварийные настройки	AL.		
	Реле	rL.		

Калибровка

Калибровка на индекс насыщения (SAT), в воде

Дисплей	Действие	Примечание
	Нажать клавишу cal , ввести код 1100, Выбор клавишей со стрелкой ▶ , числовое значение клавишей ▲ , Далее клавишей enter .	Калибровка SAT или калибровка Comp пред- варительно задается в конфигурации. Если код недействи- тельный, прибор пере- ходит назад в режим измерения.
	Поместить датчик в калибровоч- ную среду Запуск клавишей enter .	Прибор переходит в состояние Hold.
	Ввод относительной влажности Выбор клавишей со стрелкой ▶ , числовое значение клавишей ▲ , Подтвердить ввод клавишей enter .	Заданное значение относительной влажно- сти в водных средах: rH = 100 % (воздух ок. 50 %)
	Ввод калибровочного давления Выбор клавишей со стрелкой ▶ , числовое значение клавишей ▲ , Подтвердить ввод клавишей enter .	Заданное значение калибровочного дав- ления - это заданное в конфигурации техноло- гическое давление
	Автоматический контроль сдвига Отображение тока датчика (отно- сительно 25 °C и расчетного дав- ления 1013 мбар) и измеренной температуры. Контроль сдвига может произво- диться длительное время.	Возможна отмена через > 10 сек. клавишей cal , но тогда точность будет ограничена















Дисплей	Действие	Примечание
	<p>Ввод заданного индекса насыщения</p> <p>Выбор клавишей со стрелкой ▶, числовое значение клавишей ▲, Далее клавишей enter.</p>	<p>Предварительная установка - это последнее введенное значение</p>
	<p>Отображение крутизны и нулевой отметки (относительно 25°C и 1013 мбар)</p> <p>Завершить калибровку клавишей enter.</p>	<p>Повторная калибровка: Нажать клавишу cal</p>
	<p>Снова включить датчик в технологический процесс. На главном дисплее по очереди отображается индекс насыщения и "Hold", "enter" мигает.</p> <p>Запуск клавишей enter.</p>	<p>По завершении калибровки выходы еще ок. 20 секунд находятся в состоянии Hold.</p>

Указания по калибровке индекса насыщения (SAT) в воде

- В качестве калибровочной среды необходимо использовать воду, которая находится в состоянии равновесия с окружающим воздухом (индекс насыщения 100%). Кислородный обмен между водой и воздухом происходит очень медленно.
- Если калибровочная среда не находится в состоянии равновесия с воздухом и индекс насыщения калибровочной среды получен при параллельном измерении, можно ввести его вручную.
- При 2-точечной калибровке сначала произвести калибровку нулевой отметки!

Сообщения об ошибках

Ошиб-ка	Ди-сплей	Проблема Возможная причина	Аварийный контакт	Красный LED	Выход 1 (22 мА)*	Выход 2 (22 мА)*
ERR 01	Измеренное значение мигает	Диапазон измерения SAT <ul style="list-style-type: none"> • датчик поврежден • подключен неправильный датчик • Значение вышло за пределы диапазона измерения 	x	x	x	
ERR 02	Измеренное значение мигает	Диапазон измерения Сонс <ul style="list-style-type: none"> • датчик поврежден • подключен неправильный датчик • Значение вышло за пределы диапазона измерения 	x	x	x	
ERR 98	"Conf" мигает	Системная ошибка Повреждены конфигурационные или калибровочные данные, произвести полную конфигурацию прибора заново с помощью заводских настроек. После этого провести калибровку. Ошибка сохранения в программе прибора	x	x	x	x
ERR 99	"FAIL" мигает	Коррекционные данные Поврежден EEPROM или RAM Это сообщение об ошибке появляется только при полном повреждении. Прибор следует отдать на завод для ремонта и новой коррекции.	x	x	x	x

Ошибка	Дисплей	Проблема Возможная причина	Аварийный контакт	Красный LED	Выход 1 (22 мА)*	Выход 2 (22 мА)*
ERR 03		Температурный зонд Прерывание или короткое замыкание Значение вышло за пределы диапазона измерения температуры.	x	x	x	x
ERR 11		Токовый выход 1 Ток меньше 0 (3,8) мА	x	x	x	
ERR 12		Токовый выход 1 Ток больше 20,5 мА	x	x	x	
ERR 13		Токовый выход 1 Слишком большая / маленькая разница тока	x	x	x	
ERR 21		Токовый выход 2 Ток меньше 0 (3,8) мА	x	x		x
ERR 22	 	Токовый выход 2 Ток больше 20,5 мА	x	x		x
ERR 23	 	Токовый выход 2 Слишком большая / маленькая разница тока	x	x		x
ERR 33		Sensoscheck Стекланный электрод	x	x	x	
		• Ошибка нулевой отметки, Sensoface активно				
		• Ошибка крутизны, Sensoface активно				
		• Время регулировки истекло, Sensoface активно				
		• Калибровочный таймер истек, Sensoface активно				

* если для выхода в конфигурации задана авария = 22 мА



¡ADVERTENCIA!

Este breve resumen está previsto para la puesta en funcionamiento del transmisor Stratos Eco 2405 Oxy. Está destinado para los usuarios con experiencia y no evita tener que leer y cumplir las indicaciones del manual de instrucciones (incluido en el CD-ROM adjunto o, bien, en la página web www.knick.de).

Las indicaciones de seguridad se incluyen en el alcance de suministro como documentación aparte.

El Stratos Eco 2405 Oxy sirve para la medición del oxígeno disuelto y la temperatura dentro del ámbito de la biotecnología, la industria farmacéutica y en los sectores industrial, medioambiental, alimentario y de aguas residuales.

La robusta carcasa de plástico permite el montaje en panel o el montaje mural o en poste.

La cubierta protectora ofrece una protección adicional contra las influencias meteorológicas y contra los daños mecánicos.

El equipo puede sustituirse fácilmente y está concebido para sensores amperométricos, como por ejemplo Knick SE 703 / SE 706.

Dispone de dos salidas de corriente (para la transmisión de, p. ej., del valor de medición y de la temperatura), dos contactos y una conexión de alimentación universal 24 ... 230 V CA/CC, CA: 45 ... 65 Hz

Bornes de conexión:

apropiados para hilos únicos / cordones hasta 2,5 mm².

Par de apriete recomendado de los tornillos de los bornes:
0,5...0,6 Nm.

Conectar el sensor

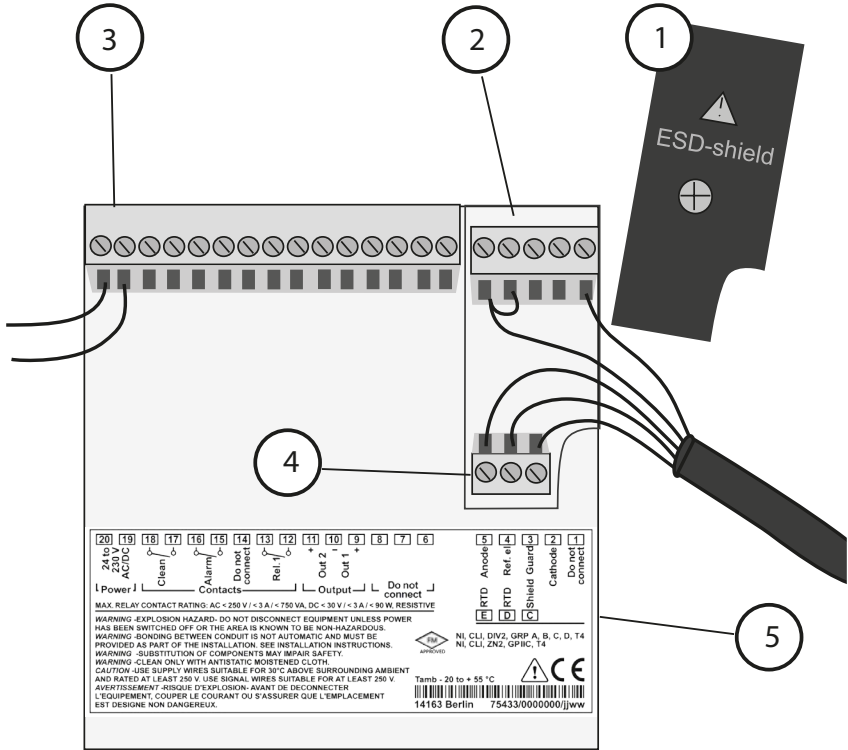

- 1 Tapa de blindaje sobre las entradas de señal (desenroscar para el montaje)
Nota: La pantalla del cable debe terminar bajo la tapa de la pantalla (se deberán cortar los conductores en caso necesario).
- 2 Bornes de conexión para el sensor
- 3 Conexión energía auxiliar
- 4 Bornes de conexión para la sonda de temperatura y la pantalla exterior
- 5 Información sobre la disposición de los bornes

Division 2 Wiring



Las conexiones del equipo se deben realizar según las normas del National Electric Code (ANSI NFPA 70) Division 2 hazardous (classified) location non-incendive wiring techniques.

Sensores con conexión a través de cable VP

Stratos Eco 2405 Oxy

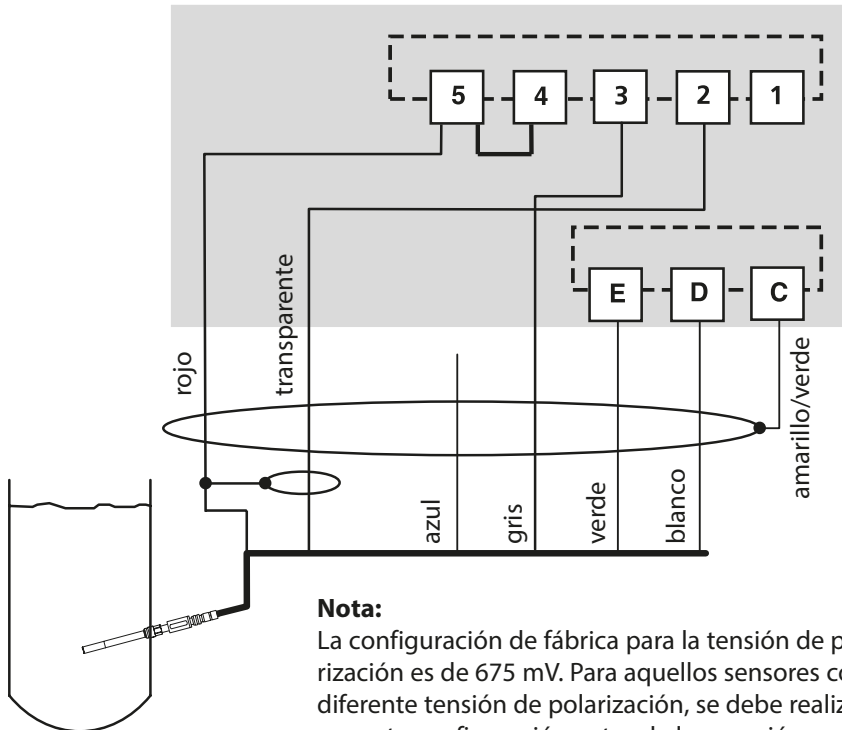

Nota:

La configuración de fábrica para la tensión de polarización es de 675 mV. Para aquellos sensores con diferente tensión de polarización, se debe realizar la correcta configuración antes de la conexión, en caso contrario se puede dañar el sensor.

Conexión	Borne	Sensor SE 703/SE 706 Cable VP (p. ej. ZU 0313)
	1	¡No conectar!
cathode	2	transparente (alma coax)
guard	3	gris
ref. el.	4	puente 4-5
anode	5	rojo (pantalla coax)
RTD	E	verde
RTD	D	blanco
shield	C	amarillo/verde

Inicio rápido

Modo de funcionamiento Medición

Tras conectar la tensión de alimentación, el equipo pasa automáticamente al modo de funcionamiento "Medición". Pulsando **cal** desde el modo de funcionamiento "Calibración", y pulsando **conf** desde el modo de funcionamiento "Configuración", se hace pasar al equipo al modo de funcionamiento "Medición" (tiempo de espera hasta que el valor de la medición se estabiliza 20 s).

Indicador Sensoface
(Estado del sensor)

Parámetro

Temperatura

Indicación del
modo de funciona-
miento (Medición)

Teclado

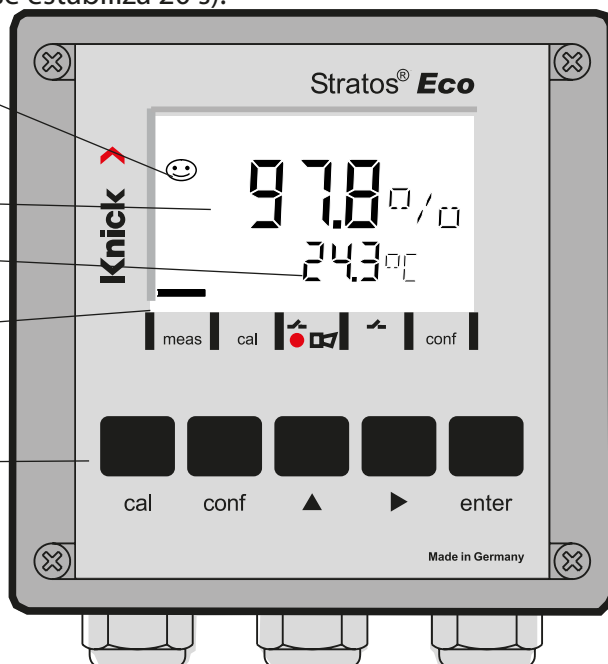

Supervisión del sensor Sensocheck, Sensoface

Sensocheck supervisa continuamente el sensor y las líneas de alimentación. Sensocheck se puede parametrizar (Configuración de fábrica: OFF).



Sensoface proporciona información sobre el estado del sensor. Durante la calibración se evalúan la pendiente y el tiempo de respuesta. Los tres pictogramas Sensoface proporcionan información de diagnóstico sobre el desgaste y la necesidad de mantenimiento del sensor.

Teclado

cal	Iniciar, terminar la calibración
conf	Iniciar, terminar la configuración
▶	<ul style="list-style-type: none"> Elegir la posición de dígito (la posición seleccionada parpadea) Navegación de menús
▲	<ul style="list-style-type: none"> Modificar posición Navegación de menús
enter	<ul style="list-style-type: none"> Calibración: Avanzar en el desarrollo del programa Configuración: Confirmar entradas, siguiente paso de la configuración Modo de medición: Indicar corriente de salida
cal → enter	Cal-Info, indicación del unto cero y de la pendiente.
conf → enter	Error-Info, indicación del último mensaje de error.
▶ + ▲	Iniciar la autoverificación GainCheck del equipo.

Passcodes

Tecla + Passcode	Opción de menú
cal + 0000	CAL-Info (Indicación punto cero, pendiente)
cal + 1001	Calibración del punto cero
cal + 1100	Calibración (Agua / aire)
cal + 1105	Calibración del producto (Punto cero)
cal + 1015	Compensación de la sonda de temperatura

Configuración

Tecla + Passcode	Opción de menú
conf + 0000	Error-Info (Visualización del último error, borrar)
conf + 1200	Configuración
conf + 2222	Control sensor (Corriente de sensor)
conf + 5555	Generador de corriente 1 (Especific. corriente de salida)
conf + 5556	Generador de corriente 2 (Especific. corriente de salida)
conf + ▶ + 4321	Configuración de fábrica

Cambiar de modo de funcionamiento / introducir valores

Requisito – El equipo se encuentra en el modo de funcionamiento “Medición”:

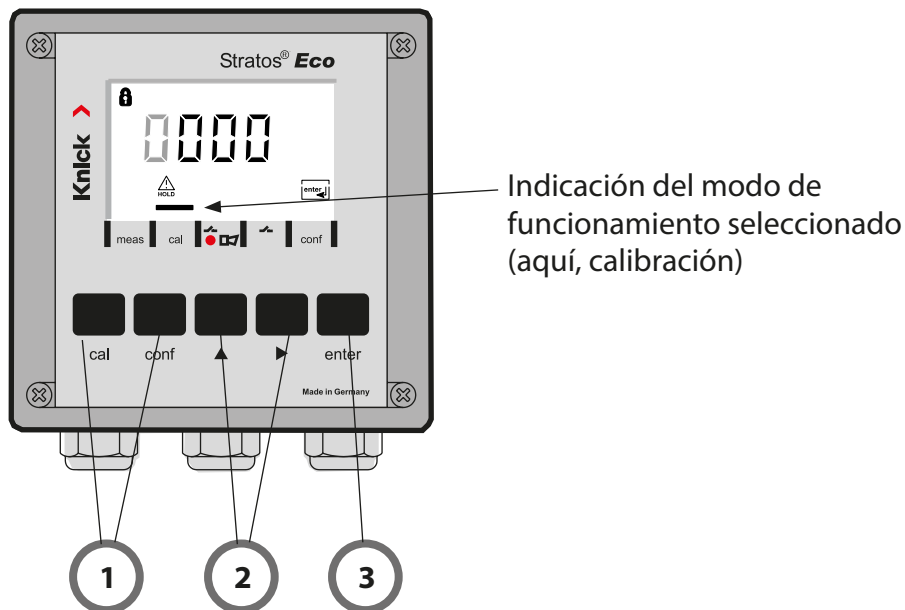

- 1) Pulsar la tecla correspondiente al modo de funcionamiento deseado para la calibración – **cal**
para la configuración – **conf**

Introducción del Passcode

- 2) Seleccionar la posición de la cifra con la tecla **▶**,
modificar el valor numérico con la tecla **▲**
- 3) Confirmar el dato introducido con la tecla **enter**

Visión general de la configuración

Los pasos de configuración están agrupados en grupos de menús. Con la ayuda de las teclas de las flechas se puede avanzar y retroceder hasta el anterior o siguiente grupo de menús.

Cada grupo de menús posee opciones de menú para la configuración de los parámetros.

Apertura de las opciones de menú con **enter**.

Para modificar los valores se usan las teclas de flecha, con **enter** se confirman/adoptan los ajustes.





Retornar a Medición: pulsar **conf**.



Elegir grupo de menús	Grupo de menús	Código	Pantalla	Elegir opción de menú
	Salida 1	o1.		enter
		Opción de menú 1		enter
		Opción de menú 2		enter
		:		enter
		Opción de menú ...		enter
	Salida 2	o2.		
	Compensación de temperatura	tc.		
	Modo de calibración	CA.		
	Ajustes de alarma	AL.		
	Relé	rL.		

Grupo de menús anterior:

Calibración

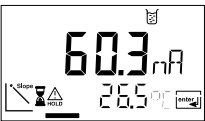
Calibración sobre índice de saturación (SAT), en agua

Pantalla	Acción	Observación
	Pulsar cal , introducir el código 1100 Seleccionar con la flecha ▶ , el valor numérico con la tecla ▲ , continuar con enter .	En la configuración se predefine la calibración SAT o la calibración Conc. Si se introduce un código incorrecto, el equipo pasa al modo de medición.
	Sumergir el sensor en el medio de calibración. Iniciar con enter .	El aparato pasa al estado Hold.
	Introducir humedad relativa Seleccionar con la flecha ▶ , el valor numérico con la tecla ▲ , Confirmar la entrada con enter .	Valor prefijado para la humedad relativa en medios acuosos: rH = 100 % (al aire aprox. 50%)
	Introducir presión de calibración Seleccionar con la flecha ▶ , el valor numérico con la tecla ▲ , Confirmar la entrada con enter .	El valor prefijado para la presión de calibración es la presión del proceso configurada
	Control automático de deriva Indicación de la corriente del sensor (referida a 25 °C y 1.013 mbar de presión normal) y de la temperatura de medición. El control de deriva puede tardar bastante tiempo.	Es posible cancelar con la tecla cal al cabo de > 10 s, pero en este caso la precisión es limitada.















Pantalla	Acción	Observación
	<p>Introducir valor de consigna para el índice de saturación. Seleccionar con la flecha ▶, el valor numérico con la tecla ▲, continuar con enter.</p>	<p>El preajuste es el último valor introducido.</p>
	<p>Indicación de la nueva pendiente y punto cero (referidos a 25 °C y 1.013 mbar). Terminar la calibración con enter.</p>	<p>Calibrar de nuevo: pulsar la tecla cal.</p>
	<p>Reintroducir el sensor en el proceso. En la pantalla principal se muestran alternativamente el índice de saturación y "Hold", "enter" parpadea. Finalizar con enter.</p>	<p>Tras finalizar la calibración, las salidas aún permanecen en el estado Hold durante aprox. 20 s.</p>

Nota sobre la calibración del índice de saturación (SAT) en agua

- Como medio de calibración se debe utilizar agua, la cual estará en estado de equilibrio con el aire del ambiente (índice de saturación 100%). El intercambio de oxígeno entre el agua y el aire solo se produce muy lentamente.
- Si el medio de calibración no se encuentra en estado de equilibrio con el aire y se conoce el índice de saturación del medio de calibración gracias a una medición desarrollada en paralelo, es posible introducirlo manualmente.
- En caso de una calibración de 2 puntos, se debe efectuar primero una calibración del punto cero.

Mensajes de error

Error	Pantalla	Problema posible causa	Contacto de alarma	LED rojo	out 1 (22 mA)*	out 2 (22 mA)*
ERR 01	El valor de medición parpadea	Rango de medición SAT <ul style="list-style-type: none"> • Fallo del sensor • Se ha conectado un sensor incorrecto • Rango de medición excedido o no alcanzado 	x	x	x	
ERR 02	El valor de medición parpadea	Rango de medición Conc <ul style="list-style-type: none"> • Fallo del sensor • Se ha conectado un sensor incorrecto • Rango de medición excedido o no alcanzado 	x	x	x	
ERR 98	"Conf" parpadea	Error del sistema Datos de la configuración o de la calibración erróneos. Vuelva a configurar de nuevo todo el equipo cargando la configuración de fábrica. Después, calibrar. Error de memoria en el programa del aparato	x	x	x	x
ERR 99	"FAIL" parpadea	Datos de compensación EEPROM o RAM defectuosas Este mensaje de error sólo aparece en caso de defecto completo. Es preciso reparar y ajustar de nuevo el aparato en la fábrica.	x	x	x	x

Error	Símbolo (parpadea)	Problema posible causa	Contacto de alarma	LED rojo	out 1 (22 mA)*	out 2 (22 mA)*
ERR 03		Sonda de temperatura Interrupción o cortocircuito Rango de medición excedido o no alcanzado.	x	x	x	x
ERR 11		Salida de corriente 1 Corriente menor a 0 (3,8) mA	x	x	x	
ERR 12		Salida de corriente 1 Corriente mayor a 20,5 mA	x	x	x	
ERR 13		Salida de corriente 1 Margen de corriente demasiado pequeño / grande	x	x	x	
ERR 21		Salida de corriente 2 Corriente menor a 0 (3,8) mA	x	x		x
ERR 22	 	Salida de corriente 2 Corriente mayor a 20,5 mA	x	x		x
ERR 23	 	Salida de corriente 2 Margen de corriente demasiado pequeño / grande	x	x		x
ERR 33		Sensocheck Electrodo de vidrio	x	x	x	
		• Error de punto cero, Sensoface activo				
		• Error de pendiente, Sensoface activo				
		• Tiempo de respuesta excedido, Sensoface activo				
		• Cronómetro de cal. expirado, Sensoface activo				

* si en la configuración se ha parametrizado la salida para la alarma = 22 mA.



AVISO!

Este pequeno resumo foi concebido para a colocação em funcionamento do Transmitter Stratos Eco 2405 Oxy. Foi pensado para o utilizador experiente e não substitui a leitura e o seguimento das indicações do manual de instruções (no CD-ROM em anexo ou na Internet em www.knick.de).

As indicações de segurança estão incluídas no material fornecido como documentação separada.

O Stratos Eco 2405 Oxy é utilizado para a medição de oxigénio dissolvido e da temperatura nas áreas da Biotecnologia, da indústria farmacêutica, assim como nas áreas do Ambiente, Produtos alimentares e do tratamento de águas residuais.

A estrutura exterior resistente em plástico permite a montagem do painel de controlo ou a fixação na parede ou num poste.

A cobertura oferece uma protecção adicional contra as influências directas das condições climatéricas e os danos mecânicos.

O aparelho é fácil de substituir e está concebido para sensores amperométricos, tais como Knick SE 703 / SE 706. Dispões de duas saídas de corrente (por ex., para a transmissão do valor de medição e da temperatura), dois contactos e uma fonte de alimentação universal 24 ... 230 V AC/DC, AC: 45 ... 65 Hz.

Bornes de ligação:

Bornes rosçados, adequados para linhas monofilares / arames flexíveis até 2,5 mm².

Binário de aperto recomendado: 0,5...0,6 Nm.

Ligar o sensor

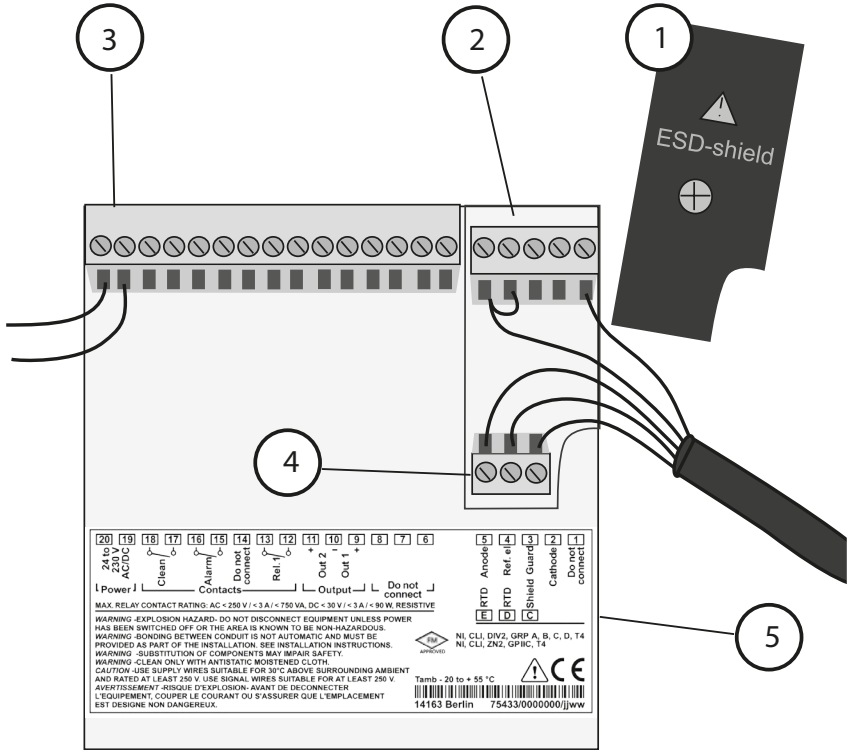

- 1 Tampa de blindagem através das entradas de sinal (desapertar para montagem)
Nota: a blindagem do cabo tem de terminar por baixo da tampa de blindagem (se necessário, cortar os fios).
- 2 Bornes de ligação para o sensor
- 3 Ligação da energia auxiliar
- 4 Bornes de ligação para o sensor de temperatura e a blindagem exterior
- 5 Indicações sobre a disposição dos bornes

Division 2 Wiring



As ligações do aparelho devem ser estabelecidas de acordo com as especificações do National Electric Code (ANSI NFPA 70) Division 2 hazardous (classified) location non-incendive wiring techniques.

Sensores com ligação através de cabo VP

Stratos Eco 2405 Oxy

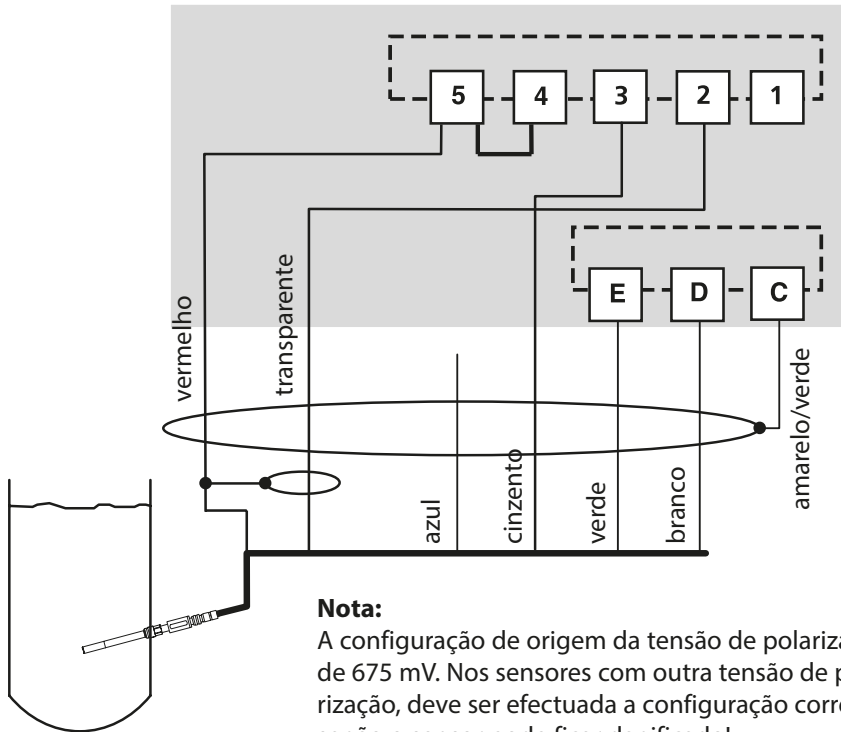

Nota:

A configuração de origem da tensão de polarização é de 675 mV. Nos sensores com outra tensão de polarização, deve ser efectuada a configuração correcta, senão o sensor pode ficar danificado!

Ligação	Borne	Sensor SE 703 / SE 706 Cabo VP (por ex., ZU 0313)
	1	não ligar!
cathode	2	transparente (alma coaxial)
guard	3	cinzento
ref. el.	4	ponte 4-5
anode	5	vermelho (blindagem coaxial)
RTD	E	verde
RTD	D	branco
shield	C	amarelo/verde

Início rápido

Modo de funcionamento de medição

Depois de se ligar a tensão de funcionamento, o aparelho entra automaticamente no modo de funcionamento "Medição". A partir do modo de funcionamento "Calibragem", o aparelho com **cal** é comutado do modo de funcionamento "Configuração", com **conf**, para o modo de funcionamento "Medição" (tempo de espera para a estabilização do valor de medição: cerca de 20 seg.)

Indicador Sensoface
(estado do sensor)

Unidade de medida

Temperatura

Indicador do modo de funcionamento (medição)

Teclado

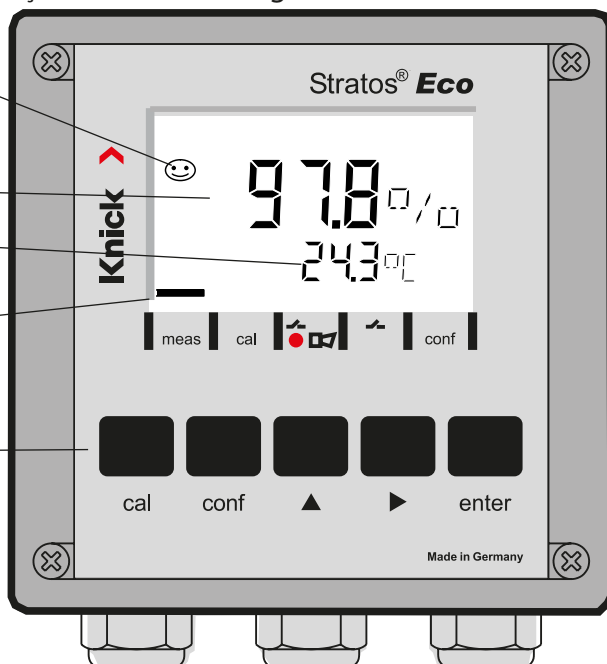

Monitorização do sensor Sensocheck, Sensoface

O Sensocheck monitoriza continuamente o sensor e os cabos.

É possível aplicar parâmetros ao Sensocheck (configuração de origem: desligado).



A Sensoface indica o estado do sensor.

O potencial de assimetria, o declive e o tempo de regulação são avaliados durante a calibragem. Os três pictogramas da Sensoface dão indicações de diagnóstico quanto ao desgaste e à necessidade de manutenção do sensor.

Teclado

cal	Iniciar, terminar a calibragem
conf	Iniciar, terminar a configuração
▶	<ul style="list-style-type: none"> • Seleccionar a posição numérica (a posição escolhida pisca) • Navegação no menu
▲	<ul style="list-style-type: none"> • Alterar a posição • Navegação no menu
enter	<ul style="list-style-type: none"> • Calibragem: Prosseguir na execução do programa • Configuração: confirmar introduções, passo de configuração seguinte • Modo de medição: exibir corrente de saída
cal → enter	Informação de cal., indicação do ponto zero e declive
conf → enter	Informação de erro, indicação da última mensagem de erro
▶ + ▲	Iniciar o auto-teste do aparelho GainCheck

Passcodes

Tecla + Passcode	Item de menu
cal + 0000	Informação de CAL (indicação do ponto zero, declive)
cal + 1001	Calibragem do ponto zero
cal + 1100	Calibragem (água / ar)
cal + 1105	Calibragem do produto (ponto zero)
cal + 1015	Ajuste do sensor de temperatura

Configuração

Tecla + Passcode	Item de menu
conf + 0000	Informação de erro (indicação do último erro, eliminar)
conf + 1200	Configuração
conf + 2222	Monitor do sensor (corrente do sensor)
conf + 5555	Fonte de corrente 1 (especificação da corrente de saída)
conf + 5556	Fonte de corrente 2 (especificação da corrente de saída)
conf + ▶ + 4321	Configuração de origem

Seleccionar o modo de funcionamento / introduzir valores

Requisito – o aparelho encontra-se no modo de funcionamento "Medição":

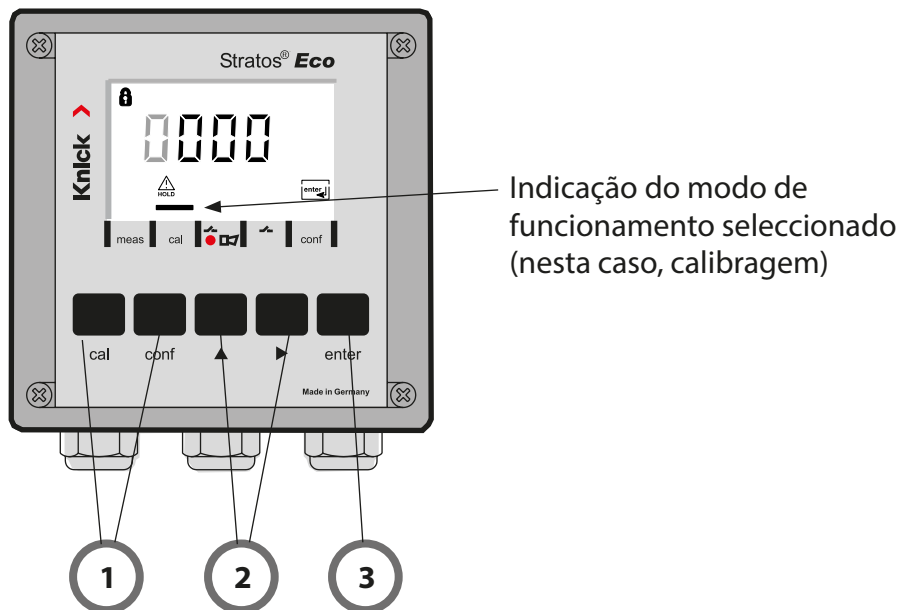

- 1) Premir a tecla correspondente ao modo de funcionamento pretendido
para calibragem – **cal**
para configuração – **conf**

Introdução do Passcode

- 2) Seleccionar a posição do algarismo com a tecla ▶ ,
alterar o valor numérico com a tecla ▲
- 3) Confirmar a introdução com **enter**

Visão geral da configuração

Os passos de configuração encontram-se reunidos em grupos de menu.

Com a ajuda das teclas de seta, é possível regressar ou avançar para o grupo de menu seguinte.

Cada grupo de menu é composto por itens de menu para a configuração dos parâmetros.

Abertura dos itens de menu com **enter**.





A alteração dos valores é efectuada com as teclas de seta, com **enter** confirmam-se/assumem-se as configurações.



Regressar à medição: premir **conf**.

Seleção do grupo de menu	Grupo de menu	Códi-go	Visor	Seleção do item de menu
▶	Saída 1	o1.	out.1 MNU ▲ o1. ▼	enter
		Item de menu 1		enter
		Item de menu 2		enter
		:		enter
	Item de menu ...			enter
▶	Saída 2	o2.	out2 MNU ▲ o2. ▼	
▶	Compensação da temperatura	tc.	tc MNU ▲ tc. ▼	
▶	Modo de calibragem	CA.	CAL MNU ▲ CA. ▼	grupo de menu anterior:
▶	Configurações do alarme	AL.	ALt MNU ▲ AL. ▼	
▶	Relé	rL.	rL MNU ▲ rL. ▼	

Calibragem

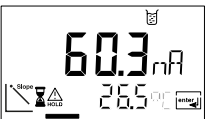
Calibragem com base no índice de saturação (SAT), na água

Visor	Acção	Observação
	Premir a tecla cal , introduzir o código 1100, Selecção com a tecla de seta ►, valor numérico com a tecla ▲, prosseguir com enter .	Na configuração, predefine-se a calibragem SAT ou calibragem Conc. No caso de um código inválido, o aparelho regressa ao modo de medição.
	Colocar o sensor no fluido de calibragem Iniciar com enter .	O aparelho entra em estado de Hold.
	Introdução da humidade relativa Selecção com tecla de seta ►, valor numérico com a tecla ▲, Confirmar a introdução com enter .	Valor padrão para a humidade relativa em fluidos aquosos: rH = 100 % (aprox. 50 % de ar)
	Introdução da pressão de calibragem Selecção com tecla de seta ►, valor numérico com a tecla ▲, Confirmar a introdução com enter .	O valor padrão para a pressão de calibragem corresponde à pressão de processo configurada
	Verificação automática de desvio Indicação da corrente do sensor (referente a 25°C e 1013 mbar de pressão normal) e da temperatura de medição. A verificação do desvio pode durar por um período mais longo de tempo.	Interrupção com a tecla cal após > 10 seg., porém depois precisão limitada

Visor	Acção	Observação
	Introdução do valor nominal para o índice de saturação Seleção com a tecla de seta ▶, valor numérico com a tecla ▲, prosseguir com enter .	A predefinição é o último valor indicado
	Exibição do novo declive e ponto zero (referente a 25°C e 1013 mbar) Terminar a calibragem com enter .	Calibrar de novo: premir a tecla cal
	Colocar o sensor novamente no processo. O índice de saturação é exibido alternadamente no visor principal com "Hold", "enter" Terminar com enter .	As saídas permanecem, depois de terminada a calibragem, ainda cerca de 20 seg. em estado de Hold.















Indicação relativa à calibragem com base no índice de saturação (SAT), na água

- Como fluido de calibragem deve ser utilizada água que se encontrar no mesmo estado de equilíbrio do ar ambiente (índice de saturação 100%). A troca de oxigénio entre a água e o ar processa-se, no entanto, de forma muito lenta.
- Se o fluido de calibragem não se encontrar no mesmo estado de equilíbrio do ar e o índice de saturação do fluido de calibragem for conhecido através de uma medição paralela, este pode ser indicado manualmente.
- No caso de uma calibragem 2 pontos, efectuar, em primeiro lugar, uma calibragem do ponto zero!

Mensagens de erro

Erro	Visor	Problema Causa possível	Contacto de alarme	LED vermelho	out 1 (22 mA)*	out 2 (22 mA)*
ERR 01	O valor de medição pisca	Amplitude de medição SAT <ul style="list-style-type: none"> • sensor avariado • sensor errado ligado • amplitude de medição ultrapassada ou não atingida 	x	x	x	
ERR 02	O valor de medição pisca	Amplitude de medição Conc <ul style="list-style-type: none"> • sensor avariado • sensor errado ligado • amplitude de medição ultrapassada ou não atingida 	x	x	x	
ERR 98	"Conf" pisca	Erro de sistema Dados de configuração ou de calibragem errados, configure e calibre o aparelho completamente com a configuração de origem. Depois, efectue a calibragem. Erro de memorização no programa do aparelho	x	x	x	x
ERR 99	"FAIL" pisca	Dados de ajuste EEPROM ou RAM avariado Esta mensagem de erro surge somente no caso de uma avaria total. O aparelho tem de ser reparado na fábrica e reajustado.	x	x	x	x

Mensagens de erro

Erro	Símbolo (pisca)	Problema Causa possível	Contacto de alarme	LED vermelho	out 1 (22 mA)*	out 2 (22 mA)*
ERR 03		Sensor de temperatura Falha ou curto-circuito Amplitude de medição da temperatura ultrapassada ou não atingida	X	X	X	X
ERR 11		Saída de corrente 1 Corrente inferior a 0 (3,8) mA	X	X	X	
ERR 12		Saída de corrente 1 Corrente superior a 20,5 mA	X	X	X	
ERR 13		Saída de corrente 1 Amplitude de corrente demasiado pequena / grande	X	X	X	
ERR 21		Saída de corrente 2 Corrente inferior a 0 (3,8) mA	X	X		X
ERR 22	 	Saída de corrente 2 Corrente superior a 20,5 mA	X	X		X
ERR 23	 	Saída de corrente 2 Amplitude de corrente demasiado pequena / grande	X	X		X
ERR 33		Sensocheck Eléctrodo de vidro	X	X	X	
		• Erro de ponto zero, Sensoface activa				
		• Erro de declive, Sensoface activa				
		• Tempo de regulação ultrapassado, Sensoface activa				
		• Temporizador de calibragem expirado, Sensoface activa				

* se a saída foi parametrizada na configuração para alarme = 22mA

Tarkoituksenmukainen käyttö



VAROITUS!

Tämä lyhyt yleiskuvaus on tarkoitettu Stratos Eco 2405 Oxy -lähettimien käyttöönottoa varten. Ohjeet on tarkoitettu kokeelle käyttäjälle eivätkä korvaa (mukana olevan cd-levyn tai Internetissä osoitteessa www.knick.de olevien) käyttöohjeiden lukemista ja noudattamista.

Turvallisuusohjeet sisältyvät toimituskokoonpanoon erillisenä asiakirjana.

Stratos Eco 2405 Oxy -laitetta käytetään liuenneen hapen mittaukseen bioteknologiassa, lääketeollisuudessa sekä teollisuus-, ympäristö-, elintarvike- ja jätevesialalla.

Laitteen vankka muovikotelo mahdollistaa asennuksen kytkenätauluun tai seinään/mastoon.

Suojakatto antaa lisäsuojaa suorilta sään vaikutuksilta ja mekaanisilta vaurioilta.

Laitte on helposti vaihdettavissa ja suunniteltu amperometriä antureita varten, kuten Knick SE 703 / SE 706. Laitteessa on kaksi virtalähtöä (esim. mittausarvon ja lämpötilan tiedonsiirtoa varten), kaksi kosketinta ja yleisvirtalähde 24 ... 230 V AC/DC, AC: 45 ... 65 Hz.

Liittimet:

ruuviliittimet, soveltuvat yksittäis- ja säikeislangoille enint. 2,5 mm². Ruuviliittimille suositeltu kiristysmomentti: 0,5...0,6 Nm.

Anturit, liitetään VP-kaapelin kautta

Stratos Eco 2405 Oxy

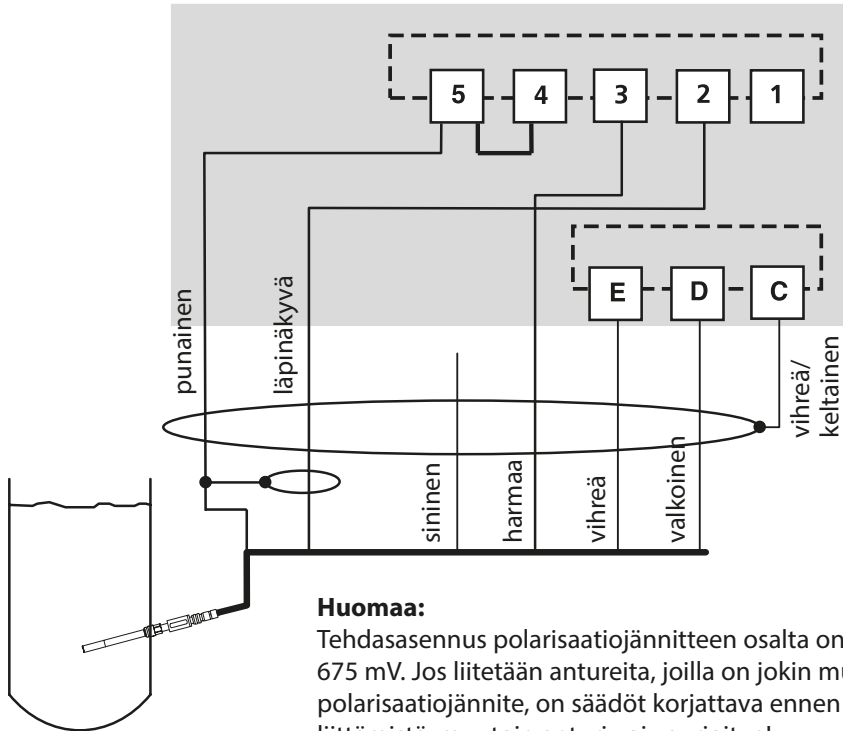

Huomaa:

Tehdasasennus polarisaatiojännitteen osalta on 675 mV. Jos liitetään antureita, joilla on jokin muu polarisaatiojännite, on säädöt korjattava ennen liittämistä, muutoin anturi voi vaurioitua!

Liitäntä	Liitin	Anturi SE 703 / SE 706 VP-kaapeli (esim. ZU 0313)
	1	ei saa kytkeä!
katodi	2	läpinäkyvä (koaksiaaliydin)
suoja	3	harmaa
ref. el.	4	silta 4-5
anodi	5	punainen (koaksiaalisojaus)
RTD	E	vihreä
RTD	D	valkoinen
shield	C	vihreä/keltainen

Pikakäynnistys

Käyttötapa Mittaus

Kun virta on kytketty päälle, siirtyy laite automaattisesti käyttötapaan "Mittaus". Käyttötavasta "Kalibrointi" laite siirtyy Mittaus-käyttötapaan painamalla **cal**, käyttötavasta "Konfigurointi" painamalla **conf** (mittausarvon vakiintumisen odotusaika n. 20 s).

Sensoface-ilmaisain
(anturin tila)

Mittausyksikkö

Lämpötila

Käyttötapa-ilmaisain
(Mittaus)

Näppäimistö

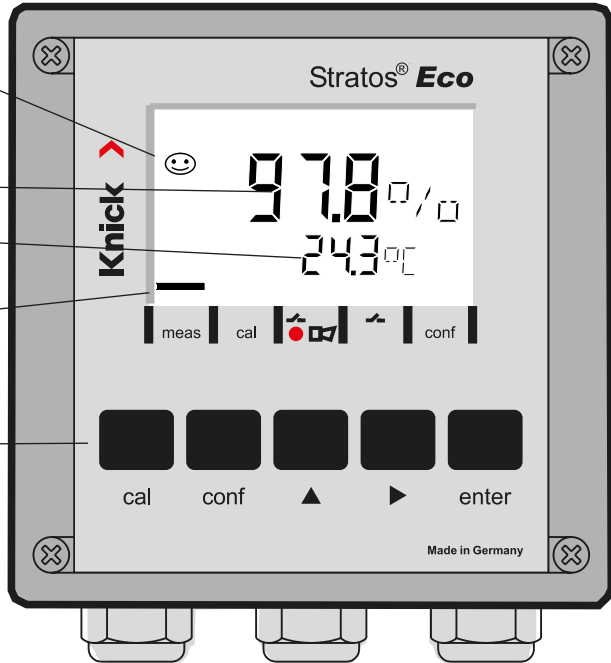

Anturivalvonta Sensocheck, Sensoface

Sensocheck valvoo jatkuvasti anturia ja sen johtoja.

Sensocheck on määritettävä (tehdasasetus: Pois päältä).



Sensoface antaa tietoja anturin tilasta.

Kulmakerroin ja säätöaika arvioidaan kalibroinnin yhteydessä. Kolme Sensoface-piktogrammia antavat tietoja anturin kulumisesta ja huoltotarpeesta.

Näppäimistö

cal	Kalibroinnin käynnistys ja lopetus
conf	Konfiguroinnin käynnistys ja lopetus
▶	<ul style="list-style-type: none"> Numeropaikan valinta (valittu paikka vilkkuu) Liikkuminen valikossa
▲	<ul style="list-style-type: none"> Paikan muuttaminen Liikkuminen valikossa
enter	<ul style="list-style-type: none"> Kalibrointi: jatka ohjelman suoritusta Konfigurointi: Tietojen vahvistaminen, seuraava konfigurointivaihe Mittauksella: näyttöä lähtövirta
cal enter	Cal-Info, nollapisteen ja kulmakertoimen näyttö
conf enter	Error-Info, viimeisimmän virheilmoituksen näyttö
▶ + ▲	Laitteen automaattinen testaus GainCheckin käynnistys

Tunnukset

Näppäin + tunnus	Valikkokohta
cal + 0000	Cal-Info (nollapisteen ja kulmakertoimen näyttö)
cal + 1001	Nollapistekalibrointi
cal + 1100	Kalibrointi (vesi/ilma)
cal + 1105	Tuotekalibrointi (nollapiste)
cal + 1015	Lämpötila-anturin tasoitus

Konfigurointi

Näppäin + tunnus	Valikkokohta
conf + 0000	Error-Info (viimeisimmän virheen näyttö, poisto)
conf + 1200	Konfigurointi
conf + 2222	Anturinäyttö (anturivirta)
conf + 5555	Virtalähde 1 (Lähtövirran oletusarvo)
conf + 5556	Virtalähde 2 (Lähtövirran oletusarvo)
conf + ▶ + 4321	Tehdasasetukset

Käyttötavan vaihtaminen / arvojen syöttäminen

**Edellytys –
laite on käyttötavassa "Mittaus":**

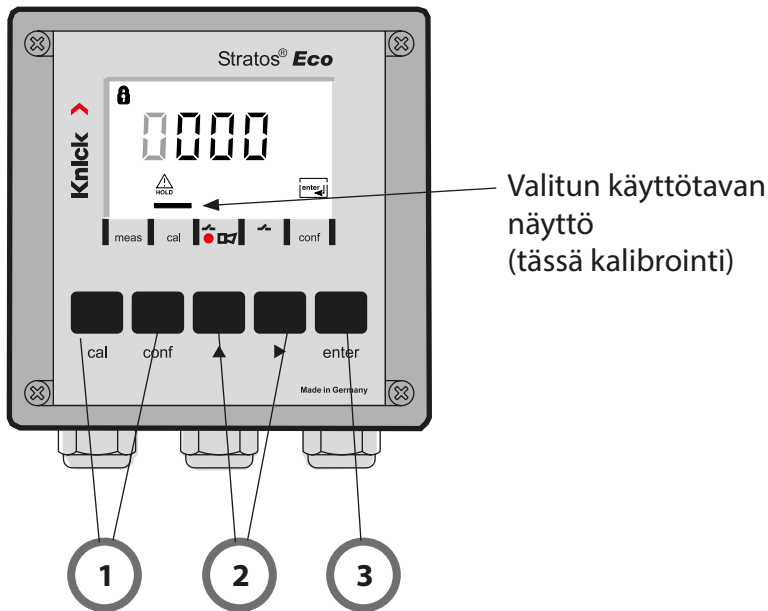

- 1) Paina haluttua käyttötapaa vastaavaa näppäintä kalibrointia varten - **cal**
konfigurointia varten - **conf**

Tunnuksen syöttäminen

- 2) Valitse numeropaikka näppäimellä ▶ ,
muuta lukuarvoa näppäimellä ▲
- 3) Vahvista syöttö painamalla **enter**

Konfiguroinnin yhteenveto







Konfigurointivaiheet on koottu valikkoryhmiksi.

Nuolinäppäinten avulla voidaan siirtyä kullekin seuraavalle valikkoryhmälle eteen tai taakse.

Joka valikkoryhmässä on valikkokohtia parametrien asettamiseksi.





Valikkokohta aukeaa painamalla **enter**. Arvojen muuttaminen tapahtuu nuolinäppäimillä, muutetut arvot vahvistetaan painamalla **enter**.



Siirtyminen takaisin mittaukseen: paina **conf**.

Valikkoryhmän valinta	Valikkoryhmä	Koodi	Näyttö	Valikkokohtan valinta
▶	Lähtö 1	o1.		enter
		Valikkokohta 1		enter
		Valikkokohta 2		enter
		:		enter
		Valikkokohta ...		enter
▶	Lähtö 2	o2.		
▶	Lämpötilan kompensointi	tc.		
▶	Kalibrointitila	CA.		edelliset valikkoryhmät:
▶	Hälytysasetukset	AL.		
▶	Rele	rL.		

Kalibrointi

Kalibrointi kylläisyysindeksille (SAT), vedessä

Näyttö	Toiminta	Huomaus
	Paina cal -näppäintä, syötä Code 1100. Valinta nuolinäppäimellä ▶ , lukuarvo näppäimellä ▲ , jatko painamalla enter .	SAT- tai Conc-kalibrointi valitaan konfigurointivaiheessa. Jos koodi ei kelpaa, siirtyy laite takaisin mittaustilaan.
	Aseta anturi kalibroitinesteeseen Käynnistä painamalla enter	Laite siirtyy Hold-tilaan
	Suhteellisen kosteuden syöttö Valinta nuolinäppäimellä ▶ , lukuarvo näppäimellä ▲ . Vahvista tiedot painamalla enter .	Oletusarvo vesipitoisten aineiden suhteelliselle kosteudelle: rH = 100 % (ilmassa n. 50 %)
	Kalibroitipaineen syöttö Valinta nuolinäppäimellä ▶ , lukuarvo näppäimellä ▲ . Vahvista tiedot painamalla enter .	Kalibroitipaineen oletusarvo on asetusten mukainen prosessipaine
	Automaattinen ryömintävalvonta Anturivirran (suhteutettuna 25 °C: een ja 1013 mbarin normaalipaineeseen) ja mittauslämpötilan näyttö. Ryömintävalvonta voi kestää jonkin aikaa.	Keskeytys yli 10 s jälkeen mahdollista painamalla cal , mutta tarkkuus kärsii















Näyttö	Toiminta	Huomautus
	Kylläisyysindeksin pitoarvon syöttö Valinta nuolinäppäimellä ▶ , lukuarvo näppäimellä ▲ , jatko painamalla enter .	Oletusarvona on viimeksi syötetty arvo
	Uuden kulmakertoimen ja nol-lapisteen näyttö (suhteutettuna 25 °C: een ja 1013 mbarin normaalipaineeseen) Lopeta kalibrointi painamalla enter .	Uudelleen kalibroiminen: paina cal -näppäintä
	Anturin saattaminen prosessiin. Kylläisyysindeksi ja "Hold" vuorottelevat päänäytössä, "enter" vilkkuu. Keskeytä painamalla enter .	Lähdöt pysyvät kalibroinnin päättymisen jälkeen vielä n 20 s ajan Hold-tilassa.

Huomautus kylläisyysindeksin (SAT) kalibrointiin vedessä

- Kalibrointiaineena tulisi käyttää vettä, joka on tasapainotilassa ympäristön ilman kanssa (kylläisyysindeksi 100%). Mutta hapen kulkeutuminen veden ja ilman välissä on hyvin hidasta.
- Jos kalibrointiaine ei ole ilman kanssa tasapainossa, ja kalibrointiaineen kylläisyysindeksi tunnetaan rinnakkaismittauksen kautta, voidaan arvo syöttää suoraan.
- Kahden pisteen kalibroinnissa on suoritettava ensin nol-lapistekalibrointi!

Virheilmoitukset

Virhe	Näyttö	Ongelma mahdollinen syy	Hälytyskosketin	punainen merkkivalo	out 1 (22 mA)*	out 2 (22 mA)*
ERR 01	Mittausarvo vilkkuu	SAT-mittausalue <ul style="list-style-type: none"> • Anturi viallinen • kytketty väärä anturi • mittausalue ylitetty tai alitettu 	x	x	x	
ERR 02	Mittausarvo vilkkuu	Conc-mittausalue <ul style="list-style-type: none"> • Anturi viallinen • kytketty väärä anturi • mittausalue ylitetty tai alitettu 	x	x	x	
ERR 98	"Conf" vilkkuu	Järjestelmävirhe Konfigurointi- tai kalibrointitiedot ovat viallisia, konfiguroi ja kalibroi laite kokonaan uudestaan tehdasasetusten avulla. Kalibroi sen jälkeen. Tallennusvirhe laitteen ohjelmistossa	x	x	x	x
ERR 99	"FAIL" vilkkuu	Tasoitustiedot EEPROM tai RAM viallinen Tämä virheilmoitus ilmestyy vain, kun vika on lopullinen. Laite on palautettava tehtaalle uutta tasausta varten.	x	x	x	x

Virhe	Symboli (vilkkuu)	Ongelma mahdollinen syy	Hälytyskosketin	punainen merkivalo	out 1 (22 mA)*	out 2 (22 mA)*
ERR 03		Lämpötila-anturi Katkos tai oikosulku Lämpötilamittausalue ylitetty tai alitettu	x	x	x	x
ERR 11		Virtalähtö 1 Virta pienempi kuin 0 (3,8) mA	x	x	x	
ERR 12		Virtalähtö 1 Virta suurempi kuin 20,5 mA	x	x	x	
ERR 13		Virtalähtö 1 Virtaväli liian pieni / liian iso	x	x	x	
ERR 21		Virtalähtö 2 Virta pienempi kuin 0 (3,8) mA	x	x		x
ERR 22	 	Virtalähtö 2 Virta suurempi kuin 20,5 mA	x	x		x
ERR 23	 	Virtalähtö 2 Virtaväli liian pieni / liian iso	x	x		x
ERR 33		Sensocheck Lasielektrodi	x	x	x	
		• Nollapistevirhe, Sensoface käytössä				
		• Kulmakerroinvirhe, Sensoface käytössä				
		• Säätoaika ylitetty, Sensoface käytössä				
		• Kalibrointiajastus päättynyt, Sensoface käytössä				

* jos lähtö on asetettu Hälytys = 22mA

Ändamålsenlig användning



VARNING!

Denna översikt är till för installationen av sändaren Stratos Eco 2405 Oxy. Översikten är tänkt för vana användare och ska inte användas som ersättning för att läsa och följa instruktionerna i bruksanvisningen (på den bifogade CD-ROM-skivan och på www.knick.de).

Säkerhetsföreskrifterna bifogas som särskild dokumentation.

Stratos Eco 2405 Oxy används för mätning av löst syre och temperatur inom bioteknologin och pharmaindustrin samt inom industri och miljö-, livsmedels- och avloppsteknik.

Det robusta plashuset tillåter montering i manöverbord, på vägg eller stolpe.

Skyddskåpan ger extra skydd mot väder och vind och mekaniska skador.

Apparaten kan enkelt bytas ut och är utformad för amperometriska sensorer, t.ex. Knick SE 703/SE 706. Den har två strömångar (för överföring av t.ex. mätvärde och temperatur), två kontakter och en universell nätspänning på 24 ... 230 V AC/DC, AC: 45 ... 65 Hz.

Anslutningskontakter:

Skruvkontakter, avsedda för enledare/flexibla ledare upp till 2,5 mm².

Rekommenderat vridmoment för kontaktskruvarna: 0,5 ... 0,6 Nm.

Sensorer med anslutning via VP-kabel

Stratos Eco 2405 Oxy

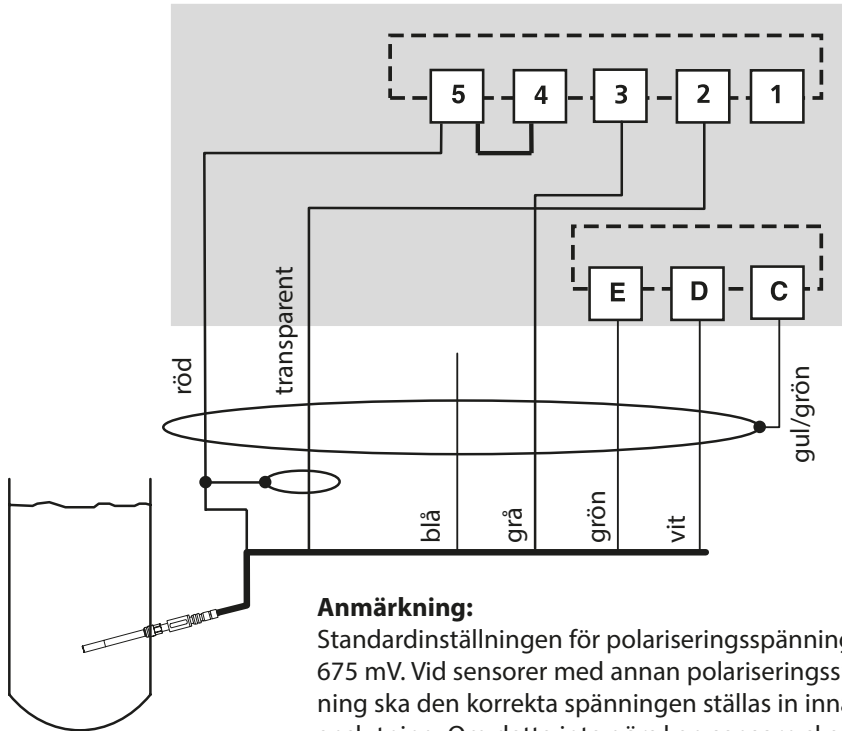

Anmärkning:

Standardinställningen för polariseringsspänningen är 675 mV. Vid sensorer med annan polariseringsspänning ska den korrekta spänningen ställas in innan anslutning. Om detta inte görs kan sensorn skadas!

Anslutning	Kontakt	Sensor SE 703/SE 706 VP-kabel (t.ex. ZU 0313)
	1	anslut inte!
cathode	2	transparent (kabelkärna koax)
guard	3	grå
ref. el.	4	bygel 4-5
anode	5	röd (skärm koax)
RTD	E	grön
RTD	D	vit
shield	C	gul/grön

Snabbstart

Driftsätt mätning

Efter inkoppling av driftspänningen övergår apparaten till läget för "Mätning". Från driftsättet "Kalibrering" nås driftsättet "Mätning" med **cal** och från driftsättet "Konfiguration" med **conf** (väntetid tills mätvärdet stabiliseras: ca 20 sek).

Sensoface-visning
(sensorstatus)

Mätstorhet

Temperatur

Visning av driftsätt
(Mätning)

Knappsats

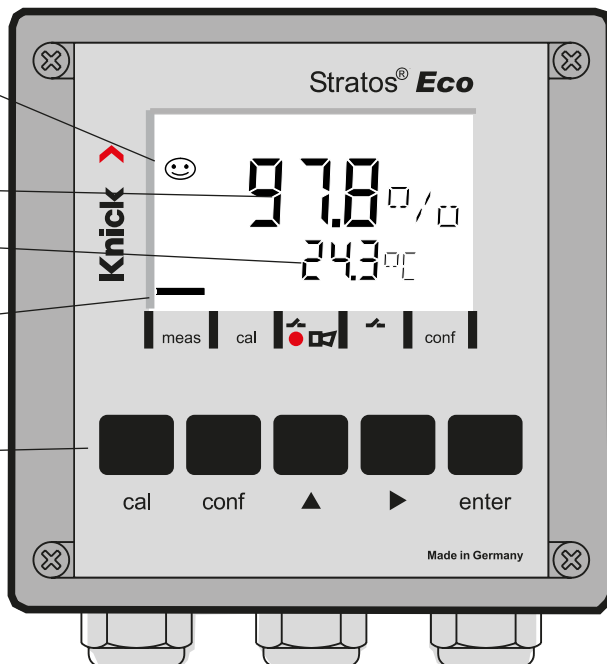

Sensorövervakning Sensocheck, Sensoface

Sensocheck övervakar kontinuerligt sensorn och dess anslutningsledningar. Sensocheck kan parametreras (fabriksinställning: av).



Sensoface ger information om sensorns tillstånd.



Branthet och inställningstid utvärderas vid kalibreringen.



De tre Sensoface-piktogrammen ger diagnosinformation om sensorns slitage och underhållsbehov.

Knappsats

cal	Starta och avsluta kalibrering
conf	Starta och avsluta konfiguration
▶	<ul style="list-style-type: none"> • Val av sifferposition (vald position blinkar) • Menynavigering
▲	<ul style="list-style-type: none"> • Inställning av siffror • Menynavigering
enter	<ul style="list-style-type: none"> • Kalibrering: vidare i programförlopp • Konfiguration: bekräfta inmatningar, nästa konfigureringssteg • Mätläge: visa utgångsström
cal → enter	Kalibreringsinformation, nollpunkt och branthet visas
conf → enter	Felinformation, det senaste felmeddelandet visas
▶ + ▲	Starta apparatens självtest GainCheck

Snabbkoder

Knapp + snabbkod	Menypunkt
cal + 0000	Kalibreringsinformation (nollpunkt och branthet visas)
cal + 1001	Nollpunktskalibrering
cal + 1100	Kalibrering (vatten/luft)
cal + 1105	Produktkalibrering (nollpunkt)
cal + 1015	Justera temperaturgivare

Konfiguration

Knapp + snabbkod	Menypunkt
conf + 0000	Felinformation (visa senaste fel, radera)
conf + 1200	Konfiguration
conf + 2222	Sensormonitor (sensorström)
conf + 5555	Strömkälla 1 (inställning av utgångsström)
conf + 5556	Strömkälla 2 (inställning av utgångsström)
conf + ▶ + 4321	Standardinställning

Byta driftsätt/mata in värden

Förutsättning:

Apparaten befinner sig i driftsättet "Mätning":

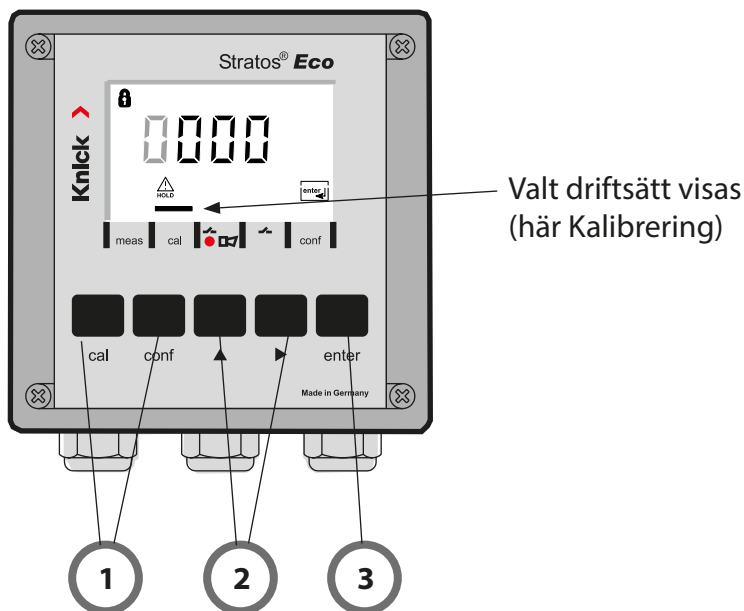

- 1) Välj driftsätt med hjälp av knapparna för kalibrering – **cal**
för konfiguration – **conf**

Mata in snabbkod

- 2) Välj sifferposition med knappen ▶ ,
ändra värdet med knappen ▲
- 3) Bekräfta inmatningen med **enter**

Översikt konfiguration

Konfigureringsstegen är sammanfattade i menygrupper.





Med hjälp av pilknapparna kan man förflytta sig framåt eller bakåt till nästa menygrupp.

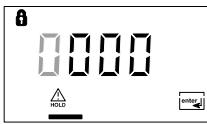

Varje menygrupp har menypunkter där parametrarna kan ställas in. Öppna menypunkterna med **enter**. Ändringen av värdena sker med pilknapparna och med **enter** bekräftas/övertas inställningarna. Tillbaka till Mätning: Tryck på **conf**.

Val menygrupp	Menygrupp	Kod	Display	Val menypunkt
▶	Utgång 1	o1.		enter
		Menypunkt 1		enter
		Menypunkt 2		enter
		:		enter
		Menypunkt ...		enter
▶	Utgång 2	o2.		
▶	Temperaturkompensation	tc.		
▶	Kalibreringsläge	CA.		föregående menygrupp:
▶	Alarminställningar	AL.		
▶	Relä	rL.		

Kalibrering

Kalibrering efter mätnadsindex (SAT), i vatten

Display	Aktion	Anmärkning
	Tryck på cal och mata in koden 1100. Välj sifferposition med pilknappen ▶ , ändra värdet med knappen ▲ , gå vidare med enter .	Kalibrering SAT eller kalibrering Conc förinställs under konfigurationen. Vid ogiltig kod går apparaten tillbaka till mätläget.
	Doppa sensorn i kalibreringsmediet. Starta med enter .	Apparaten övergår till status HOLD.
	Mata in relativ fuktighet Välj sifferposition med pilknappen ▶ , ändra värdet med knappen ▲ . Bekräfta med enter .	Standardvärde för relativ fuktighet i vattenhaltiga medier: rH = 100 % (mot luft ca 50 %)
	Mata in kalibreringstryck Välj sifferposition med pilknappen ▶ , ändra värdet med knappen ▲ . Bekräfta med enter .	Standardvärdet för kalibreringstrycket är det konfigurerade processtrycket.
	Automatisk driftkontroll Sensorströmmen (med 25 °C och 1013 mbar normaltryck som referens) och mättemperaturen visas. Driftkontrollen kan ta tid.	Driftkontrollen kan avbrytas med cal efter minst 10 sek. Detta innebär dock sänkt precision.















Display	Aktion	Anmärkning
	<p>Mata in börvärdet för mätnadsindexet</p> <p>Välj sifferposition med pilknappen ▶ , ändra värdet med knappen ▲ , gå vidare med enter.</p>	<p>Värdet är förinställt på det senast inmatade värdet.</p>
	<p>Ny branhet och nollpunkt (med 25 °C och 1013 mbar som referens) visas.</p> <p>Avsluta kalibreringen med enter.</p>	<p>För att kalibrera på nytt: Tryck på cal.</p>
	<p>Återför sensorn till processen.</p> <p>Mätnadsindexet visas växelvis med "Hold" i huvudfältet, och "enter" blinkar.</p> <p>Avsluta med enter.</p>	<p>Utgångarna förblir i HOLD-status ca 20 sek efter att kalibreringen har avslutats.</p>

Tips för kalibrering mätnadsindex (SAT) i vatten

- Kalibreringsmediet bör utgöras av vatten i jämvikt med den omgivande luften (mätnadsindex 100 %). Syreutbytet mellan vatten och luft sker dock mycket långsamt.
- Om kalibreringsmediet inte är i jämvikt med luften och kalibreringsmediets mätnadsindex är känt genom samtidigt genomförd mätning kan det matas in manuellt.
- Vid 2-punktskalibrering ska en nollpunktskalibrering genomföras först!

Felmeddelanden

Fel	Display	Problem möjlig orsak	Alarmkontakt	Röd lysdiod	out 1 (22 mA)*	out 2 (22 mA)*
ERR 01	Mätvärdet blinkar	Mätområde SAT <ul style="list-style-type: none"> • sensor defekt • fel sensor ansluten • mätområdet över- eller underskridet 	x	x	x	
ERR 02	Mätvärdet blinkar	Mätområde Conc <ul style="list-style-type: none"> • sensor defekt • fel sensor ansluten • mätområdet över- eller underskridet 	x	x	x	
ERR 98	"Conf" blinkar	Systemfel Konfigurerings- eller kalibreringsdata defekta, konfigurera apparaten på nytt med hjälp av standardinställning. Kalibrera därefter. Minnesfel i apparatens program	x	x	x	x
ERR 99	"FAIL" blinkar	Justeringsdata EEPROM eller RAM defekt Detta felmeddelande uppträder bara vid en komplett defekt. Apparaten måste repareras på fabrik och kalibreras på nytt.	x	x	x	x

Fel	Symbol (blinker)	Problem möjlig orsak	Alarmkontakt	Röd lysdiod	out 1 (22 mA)*	out 2 (22 mA)*
ERR 03		Temperaturgivare Avbrott eller kortslutning Temperaturmätområdet över- eller underskridet	x	x	x	x
ERR 11		Ström utgång 1 Ström lägre än 0 (3,8) mA	x	x	x	
ERR 12		Ström utgång 1 Ström högre än 20,5 mA	x	x	x	
ERR 13		Ström utgång 1 Strömspann för litet/för stort	x	x	x	
ERR 21		Ström utgång 2 Ström lägre än 0 (3,8) mA	x	x		x
ERR 22	 	Ström utgång 2 Ström högre än 20,5 mA	x	x		x
ERR 23	 	Ström utgång 2 Strömspann för litet/för stort	x	x		x
ERR 33		Sensocheck Glaselektrod	x	x	x	
		• Nollpunktsfel, Sensoface aktivt				
		• Branthetsfel, Sensoface aktivt				
		• Inställningstid överskriden, Sensoface aktivt				
		• Kalibreringstiden har gått ut, Sensoface aktivt				

* under förutsättning att parametern i konfigurationen ställdes in till Alarm = 22 mA



警告！

该简短说明用于发射机 STRATOS ECO 2405 OXY 的调试。。它适于具有经验的用户阅读，并不能替代阅读和遵循操作说明（参见随附的 CD-ROM 或访问链接 WWW.KNICK.DE）中的指示。

安全提示作为特殊资料随同供货。

Stratos Eco 2405 Oxy 用于测量溶解的氧气与温度。应用领域包括生物技术、制药以及应用于工业、环保、食品与废水领域。耐用的塑料外罩适用于配电盘的安装或墙装以及支架的安装。保护棚提供额外的保护，避免大气的直接影响和机械损伤。该设备方便更换，并专用于测量电流的传感器，例如 Knick SE 703 / SE 706。该设备有两个电流输出端（用于例如测量值与温度的传输）、两个触点和一个通用电源 24 ... 230 V AC/DC, AC: 45 ... 65 Hz。

接线端子：

螺丝接线柱，适用于最大 2.5 mm² 的单导线/绞合线。 螺丝接线柱的建议起动力矩： 0.5...0.6 Nm。

连接传感器

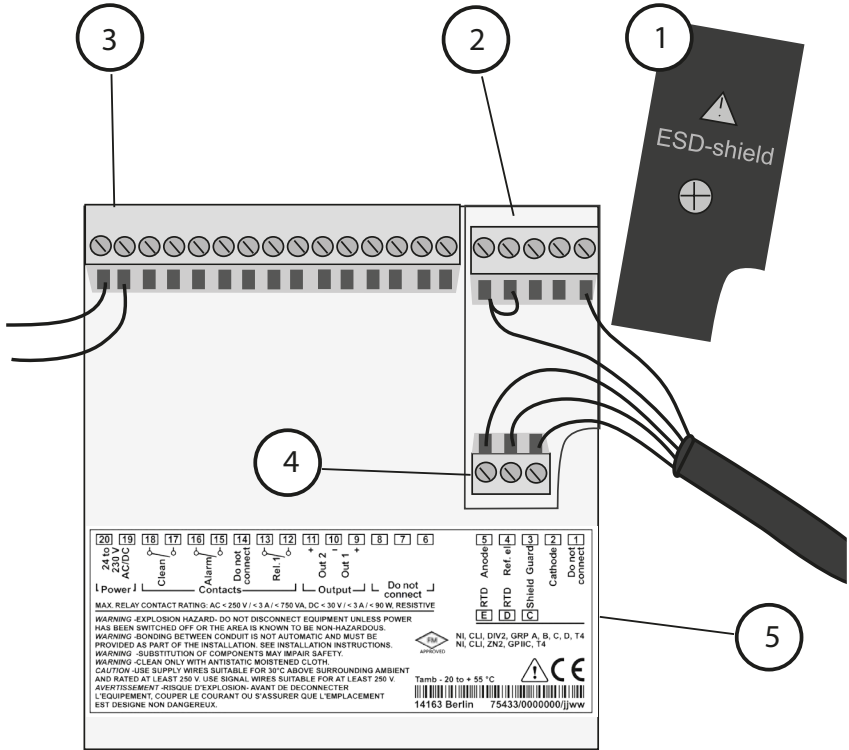

- 1 信号输入端的屏蔽罩（安装时拧出）
提示： 电缆屏蔽必须在屏蔽罩下结束（必要时相应地缩短导线）。
- 2 传感器接线端子
- 3 辅助电源接线
- 4 温度传感器和外部屏蔽的接线端子
- 5 接线端子的布线说明

Division 2 Wiring



必须根据 National Electric Code (ANSI NFPA 70) Division 2 hazardous (classified) location non-incident wiring technique 的规定完成设备的接线。

通过 VP 电缆连接传感器

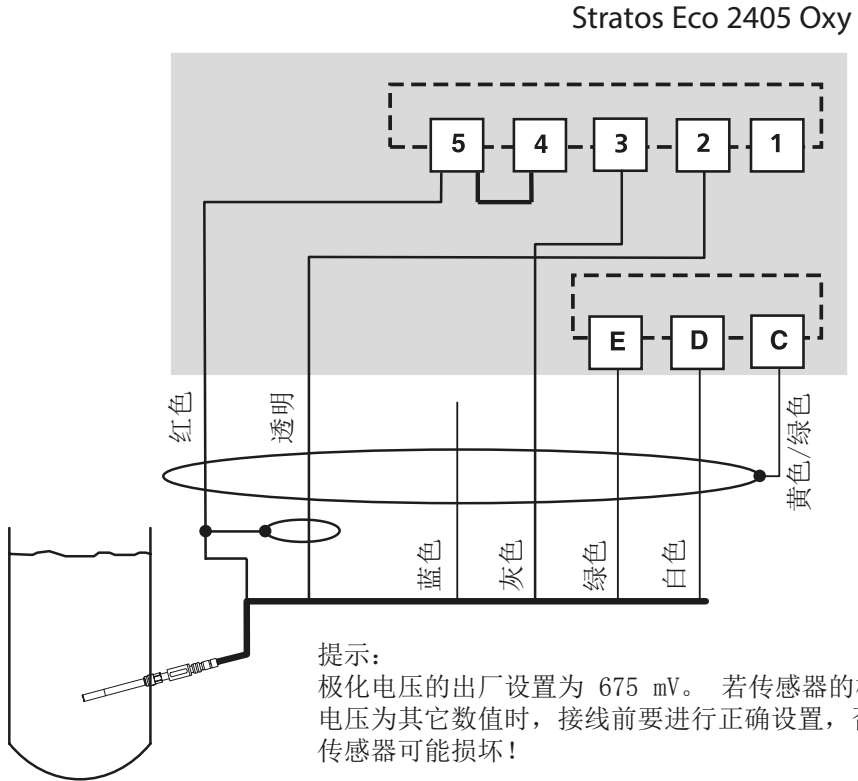

接线	端子	传感器 SE 703 / SE 706 VP 电缆 (例如 ZU 0313)
	1	勿接线!
cathode	2	透明 (芯线 Koax)
guard	3	灰色
ref. el.	4	桥接 4-5
anode	5	红色 (屏蔽 Koax)
RTD	E	绿色
RTD	D	白色
shield	C	黄色/绿色

快速启动

测量运行方式

接通电源后，设备进入“测量”运行方式。设备可通过按 **cal** 从“校准”运行方式或按 **conf** 从“配置”运行方式切换到“测量”运行方式（到测量值稳定时的等待时间约为 20 秒）。

Sensoface 显示
(传感器状态)

测量值

温度

运行方式显示 (测
量)

键盘

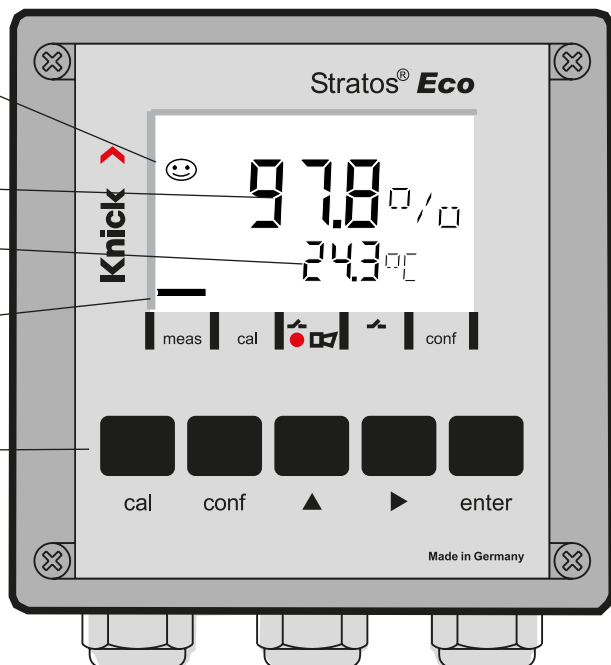

传感器监控 Sensoscheck, Sensoface

Sensoscheck 持续监控传感器与引线。Sensoscheck 可用参数表示（出厂设置：关闭）。



Sensoface 显示有关传感器状态的提示。

斜率和设置时间将在校准时计算出。这三个 Sensoface 图标显示有关传感器磨损和维修需求的诊断提示

键盘

cal	开始和结束校准
conf	开始和结束配置
▶	<ul style="list-style-type: none"> 选择数位（选中的数位会闪动） 菜单导航
▲	<ul style="list-style-type: none"> 更改数位 菜单导航
enter	<ul style="list-style-type: none"> 校准：继续运行程序 配置：确认输入，下一配置步骤 测量模式：显示输出电流
cal → enter	Cal 信息，显示零点和斜率
conf → enter	Error 信息，显示最近的错误信息
▶ + ▲	启动设备自测试 GainCheck

Passcodes

按键 + Passcode	菜单项
cal + 0000	CAL 信息（显示零点、斜率）
cal + 1001	零点校准
cal + 1100	校准（水 / 空气）
cal + 1105	产品校准（零点）
cal + 1015	调节温度传感器

配置

按键 + Passcode	菜单项
conf + 0000	Error 信息（显示最近的错误，删除）
conf + 1200	配置
conf + 2222	传感器监控器（传感器电流）
conf + 5555	电流传感器 1（默认输出电流）
conf + 5556	电流传感器 2（默认输出电流）
conf + ▶ + 4321	出厂设置

切换运行方式 / 输入数值

前提条件 -
设备处于“测量”运行方式：

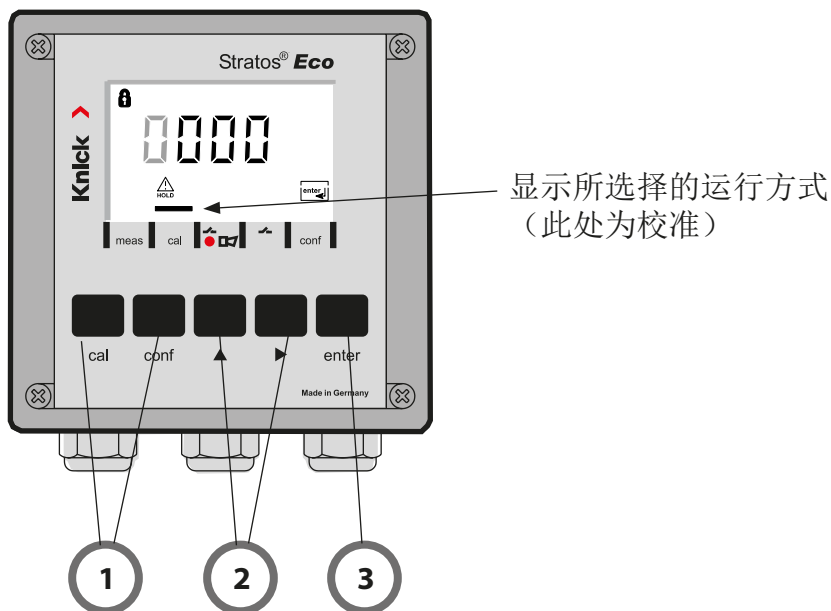

- 1) 根据所需运行方式按下按键
校准 - **cal**
配置 - **conf**

输入 Passcode

- 2) 用按键 **▶** 选择数字位置，用按键 **▲** 修改数值
- 3) 用按键 **enter** 确认输入

配置步骤汇总在菜单组。用箭头按键可向前或向后分别跳到下一个菜单组。

每个菜单组都有设置参数的菜单项。按 **enter** 键打开菜单项。通过箭头按键更改数值，按 **enter** 键确定/接受该设置。

返回测量：按下 **conf**。

选择菜单组	菜单组	Code	显示	选择菜单项
	输出端 1	o1.		enter enter enter enter
		菜单项 1		
		菜单项 2		
		...		
		菜单项 ...		
	输出端 2	o2.		
	温度补偿	tc.		
	校准模块	CA.		前一菜单组
	警报设置	AL.		
	继电器	rL.		

校准

在水中校准饱和系数 (SAT)

显示	操作	备注
	按下 cal 键，输入 Code 1100，按 ▶ 箭头键进行选择，按 ▲ ，键更改数值，按 enter 继续	配置中预设定 SAT 校准或 Conc 校准。 Code 无效时，设备将返回到测量模式。
	将传感器放入校准介质 按 enter 键启动。	设备进入 Hold 状态。
	输入相对湿度，按 ▶ 箭头键进行选择，按 ▲ 键更改数值，按 enter 继续。	湿润介质中相对湿度的设定值：rH = 100 % (空气中约为 50 %)
	输入校准压力，按 ▶ 箭头键进行选择，按 ▲ 键更改数值，按 enter 继续。	校准压力的设定值是已配置的生产过程压力
	自动漂移检测 显示传感器电流 (基于 25 °C 和 1013 mbar 常用压力) 和测量温度。 漂移检测可以持续较长时间。	按下按键 cal > 10 秒后可能中断，但精确度会受到限制

显示	操作	备注
	输入饱和系数的额定值，按 ▶ ，箭头键进行选择，按 ▲ 键更改数值，按 enter 继续。	预设值是最后一次输入的数值
	显示新斜率和零点（基于 25° C 和 1013 mbar） 按 enter 键结束校准。	重新校准：按下 cal 键
	传感器再次工作。饱和系数在主显示器中用“Hold”交替显示，“enter”闪烁。 按 enter 键结束。	校准结束后，输出端仍在 Hold 状态保持约 20 秒钟。

在水中校准饱和系数（SAT）的提示

- 校准介质应使用水，并且所用的水要与空气环境成平衡状态（饱和系数 100%）。水和空气之间的氧气交换过程十分缓慢。
- 如果校准介质与空气不处于平衡状态，并且校准介质的饱和系数通过同时进行的测量已计算出，则可以手动输入饱和系数。
- 对于 2 点校准来说，首先要进行零点校准！

错误信息

错误	显示	问题 可能的原因	报警接点	红色 LED	out 1 (22 mA)*	out 2 (22 mA)*
ERR 01	测量值闪烁	SAT 测量范围 <ul style="list-style-type: none"> • 传感器故障 • 连接错误的传感器 • 测量范围不足或超出 	x	x	x	
ERR 02	测量值闪烁	Conc 测量范围 <ul style="list-style-type: none"> • 传感器故障 • 连接错误的传感器 • 测量范围不足或超出 	x	x	x	
ERR 98	“Conf” 闪烁	系统错误 配置或校准数据错误，请使用出厂设置重新配置设备。然后校准。设备程序中存储器错误	x	x	x	x
ERR 99	“FAIL” 闪烁	调整数据 EEPROM 或 RAM 受损 仅在完全受损时才显示此错误提示。 设备必须在工厂修理，并重新校准。	x	x	x	x

错误	符号 (闪烁)	问题 可能的原因	报警接点	红色 LED	out 1 (22 mA)*	out 2 (22 mA)*
ERR 03		温度传感器 中断或短路 温度测量范围超出或不足	x	x	x	x
ERR 11		电流输出端 1 电流小于 0 (3.8) mA	x	x	x	
ERR 12		电流输出端 1 电流大于 20.5 mA	x	x	x	
ERR 13		电流输出端 1 电流电压过小 / 过大	x	x	x	
ERR 21		电流输出端 2 电流小于 0 (3.8) mA	x	x		x
ERR 22	 	电流输出端 2 电流大于 20.5 mA	x	x		x
ERR 23	 	电流输出端 2 电流电压过小 / 过大	x	x		x
ERR 33		Sensocheck 玻璃电极	x	x	x	
		• 零点错误, Sensoface 激活				
		• 斜度错误, Sensoface 激活				
		• 设置时间超出, Sensoface 激活				
		• 校准时间过期, Sensoface 激活				

* 当配置中的输出在报警 = 22mA 时已参数化



Knick
Elektronische Messgeräte
GmbH & Co. KG

Headquarters

Beuckestraße 22 • 14163 Berlin
Germany

Phone: +49 30 80191-0

Fax: +49 30 80191-200

info@knick.de

www.knick.de

Local Contacts

www.knick-international.com

Copyright 2020 • Subject to change

This document was last updated on April 6, 2020

The latest documents are available for download on our website
under the corresponding product description.



096951

TE-194.433-KNXX03 20200406